

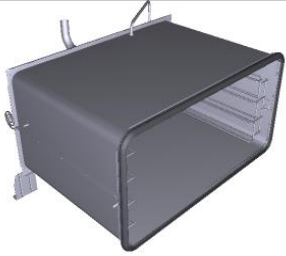



Assembly code	Assembly revision	Assembly image
ASM0027B/0.D00	Door	
ASM2012D/0.D00	Cooking chamber	
ASM2013D/0.D01	External cover	
ASM2014F/0.D00	Electrical system	

ASM0027B/0.D00 - Door

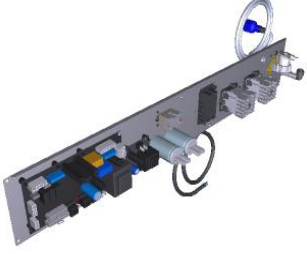
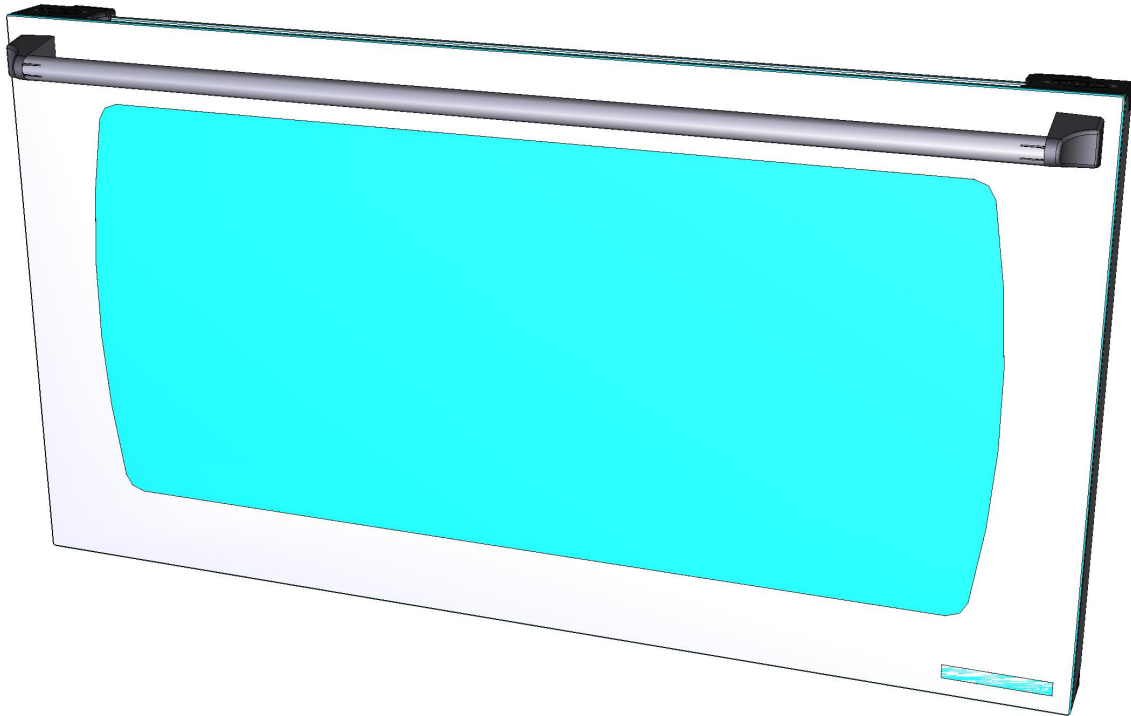

FRONT

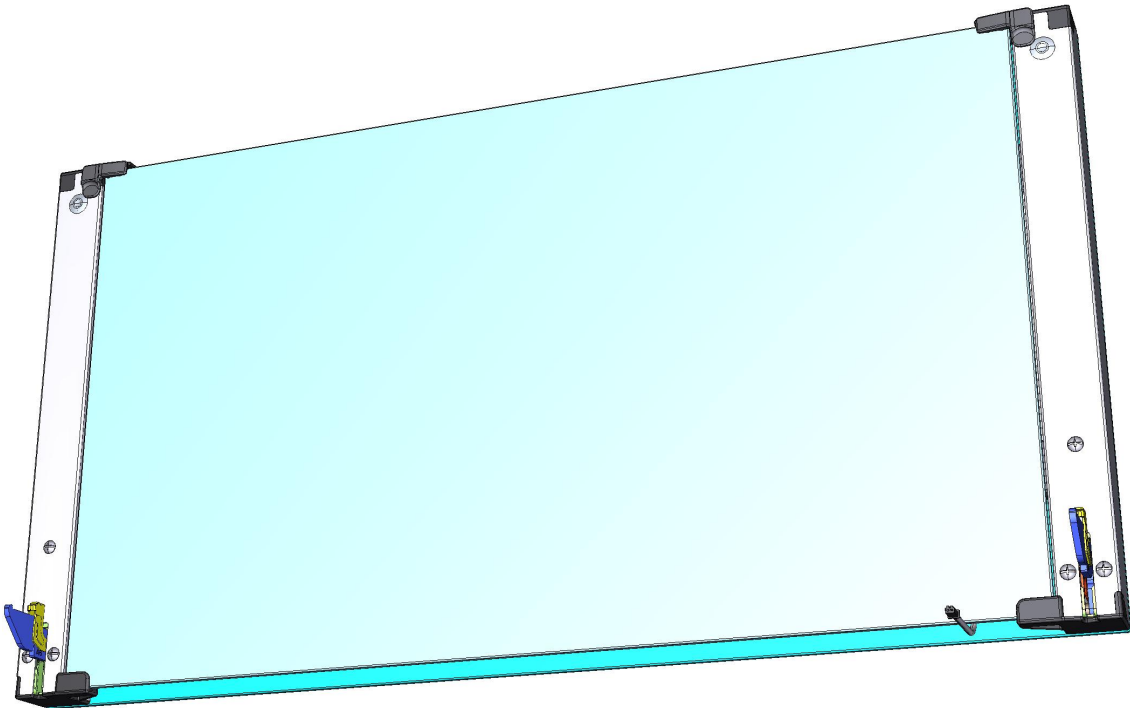

ASM0027B/0.D00 - Door

REAR

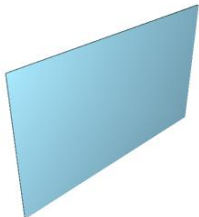
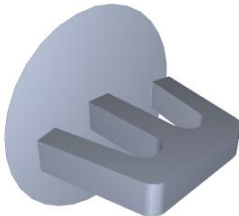

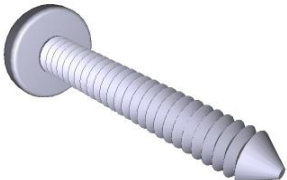
COMPONENT			SPARE PART																																		
Code	Description	Image	Code	Description	Components list																																
VT1070B	LINEMISS ROSSELLA INTERNAL GLASS		KVT1070B	L.MISS ROSSELLA INTERNAL GLASS KI	<table border="1"> <thead> <tr> <th>Code</th> <th>Description</th> <th>Qty</th> <th>UOM</th> </tr> </thead> <tbody> <tr> <td>ED1011A0</td> <td>GLASS LABEL</td> <td>1</td> <td>PZ</td> </tr> <tr> <td>ED1235A0</td> <td>INTERNAL GLASS LABEL</td> <td>1</td> <td>PZ</td> </tr> <tr> <td>GN1265A0</td> <td>INTERNAL GLASS SEAL</td> <td>4</td> <td>PZ</td> </tr> <tr> <td>IP1508A0</td> <td></td> <td>1.130</td> <td>PZ</td> </tr> <tr> <td>IP1508A1</td> <td>POLYSTYREN E U SHAPED PROFILE 2000X60X60</td> <td>2</td> <td>M</td> </tr> <tr> <td>VM1059A1</td> <td>HEAT SHRINK FILM H800</td> <td>1.700</td> <td>M</td> </tr> <tr> <td>VT1070B0</td> <td>LINEMISS ROSSELLA INTERNAL GLASS</td> <td>1</td> <td>PZ</td> </tr> </tbody> </table>	Code	Description	Qty	UOM	ED1011A0	GLASS LABEL	1	PZ	ED1235A0	INTERNAL GLASS LABEL	1	PZ	GN1265A0	INTERNAL GLASS SEAL	4	PZ	IP1508A0		1.130	PZ	IP1508A1	POLYSTYREN E U SHAPED PROFILE 2000X60X60	2	M	VM1059A1	HEAT SHRINK FILM H800	1.700	M	VT1070B0	LINEMISS ROSSELLA INTERNAL GLASS	1	PZ
Code	Description	Qty	UOM																																		
ED1011A0	GLASS LABEL	1	PZ																																		
ED1235A0	INTERNAL GLASS LABEL	1	PZ																																		
GN1265A0	INTERNAL GLASS SEAL	4	PZ																																		
IP1508A0		1.130	PZ																																		
IP1508A1	POLYSTYREN E U SHAPED PROFILE 2000X60X60	2	M																																		
VM1059A1	HEAT SHRINK FILM H800	1.700	M																																		
VT1070B0	LINEMISS ROSSELLA INTERNAL GLASS	1	PZ																																		
VM1025A	Ø16 GREY NYLON LI		KVM1025A	GREY NYLON CAPS 20 PCS KIT	<table border="1"> <thead> <tr> <th>Code</th> <th>Description</th> <th>Qty</th> <th>UOM</th> </tr> </thead> <tbody> <tr> <td>VM1025A0</td> <td>Ø16 GREY NYLON LID</td> <td>20</td> <td>PZ</td> </tr> </tbody> </table>	Code	Description	Qty	UOM	VM1025A0	Ø16 GREY NYLON LID	20	PZ																								
Code	Description	Qty	UOM																																		
VM1025A0	Ø16 GREY NYLON LID	20	PZ																																		
MG1015B	L.MISS/L.MICRO/CH EFTOP HANDLE END		KMG1015B	2 PCS. HANDLE END KIT	<table border="1"> <thead> <tr> <th>Code</th> <th>Description</th> <th>Qty</th> <th>UOM</th> </tr> </thead> <tbody> <tr> <td>MG1015B0</td> <td>L.MISS/L.MICR O/CHEFTOP HANDLE END</td> <td>2</td> <td>PZ</td> </tr> <tr> <td>VI1855A0</td> <td>5X25 SELF-TAPPIN G SCREW</td> <td>2</td> <td>PZ</td> </tr> <tr> <td>VI1870A0</td> <td>50X50 SELF-THREADI NG SCREW FOR PLASTIC</td> <td>2</td> <td>PZ</td> </tr> <tr> <td>VM1025A0</td> <td>Ø16 GREY NYLON LID</td> <td>2</td> <td>PZ</td> </tr> </tbody> </table>	Code	Description	Qty	UOM	MG1015B0	L.MISS/L.MICR O/CHEFTOP HANDLE END	2	PZ	VI1855A0	5X25 SELF-TAPPIN G SCREW	2	PZ	VI1870A0	50X50 SELF-THREADI NG SCREW FOR PLASTIC	2	PZ	VM1025A0	Ø16 GREY NYLON LID	2	PZ												
Code	Description	Qty	UOM																																		
MG1015B0	L.MISS/L.MICR O/CHEFTOP HANDLE END	2	PZ																																		
VI1855A0	5X25 SELF-TAPPIN G SCREW	2	PZ																																		
VI1870A0	50X50 SELF-THREADI NG SCREW FOR PLASTIC	2	PZ																																		
VM1025A0	Ø16 GREY NYLON LID	2	PZ																																		
VI1855A	5X25 SELF-TAPPING SCREW		KVI1855A	5X25 SELF-TAPPING SCREW 20 PCS.	<table border="1"> <thead> <tr> <th>Code</th> <th>Description</th> <th>Qty</th> <th>UOM</th> </tr> </thead> <tbody> <tr> <td>VI1855A0</td> <td>5X25 SELF-TAPPIN G SCREW</td> <td>20</td> <td>PZ</td> </tr> </tbody> </table>	Code	Description	Qty	UOM	VI1855A0	5X25 SELF-TAPPIN G SCREW	20	PZ																								
Code	Description	Qty	UOM																																		
VI1855A0	5X25 SELF-TAPPIN G SCREW	20	PZ																																		

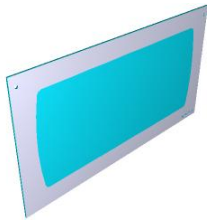

COMPONENT			SPARE PART																																																																													
Code	Description	Image	Code	Description	Components list																																																																											
VT1072A	LINEMISS ROSSELLA BLACK EXTERNAL GLASS		KVT1072A	L.M. ROSSELLA BLACK EXTERNAL GLASS KIT	<table border="1"> <thead> <tr> <th>Code</th> <th>Description</th> <th>Qty</th> <th>UOM</th> </tr> </thead> <tbody> <tr> <td>IP1385A1</td> <td>CORNER POLYSTYREN E PACKING 110X80X2000</td> <td>0.960</td> <td>M</td> </tr> <tr> <td>IP1508A0</td> <td></td> <td>1.280</td> <td>PZ</td> </tr> <tr> <td>IP1508A1</td> <td>POLYSTYREN E U SHAPED PROFILE 2000X60X60</td> <td>1.270</td> <td>M</td> </tr> <tr> <td>RC1200A0</td> <td>ED=4 WIRE D.=0.5 COMPRESSIO N SPRING</td> <td>2</td> <td>PZ</td> </tr> <tr> <td>SL1050A1</td> <td>3M TRANSFER ADHESIVE TAPE</td> <td>0.820</td> <td>M</td> </tr> <tr> <td>TB2301A0</td> <td>RIGHT COLUMN XVC105E 40X40X1</td> <td>2</td> <td>PZ</td> </tr> <tr> <td>TB3081A0</td> <td>LMISS ARIANNA/ROS SELLA DOOR LEFT COLUMN</td> <td>1</td> <td>PZ</td> </tr> <tr> <td>VM1025A0</td> <td>Ø16 GREY NYLON LID</td> <td>2</td> <td>PZ</td> </tr> <tr> <td>VM1059A1</td> <td>HEAT SHRINK FILM H800</td> <td>1.300</td> <td>M</td> </tr> <tr> <td>VM1695A0</td> <td>HANDLE POSITION PIN</td> <td>2</td> <td>PZ</td> </tr> <tr> <td>VM1916A0</td> <td>RIGHT UPPER COLUMN CAP</td> <td>1</td> <td>PZ</td> </tr> <tr> <td>VM1917A0</td> <td>LEFT UPPER COLUMN CAP</td> <td>1</td> <td>PZ</td> </tr> <tr> <td>VM1918A0</td> <td>RIGHT LOWER COLUMN CAP</td> <td>1</td> <td>PZ</td> </tr> <tr> <td>VM1919A0</td> <td>LEFT LOWER COLUMN CAP</td> <td>1</td> <td>PZ</td> </tr> <tr> <td>VM1920A0</td> <td>INTERNAL GLASS CLOSING RIGHT PLATE</td> <td>1</td> <td>PZ</td> </tr> <tr> <td>VM1921A0</td> <td>INTERNAL GLASS CLOSING LEFT PLATE</td> <td>1</td> <td>PZ</td> </tr> <tr> <td>VT1072A0</td> <td>LINEMISS ROSSELLA BLACK EXTERNAL GLASS</td> <td></td> <td></td> <td></td> <td>1</td> <td>PZ</td> </tr> </tbody> </table>	Code	Description	Qty	UOM	IP1385A1	CORNER POLYSTYREN E PACKING 110X80X2000	0.960	M	IP1508A0		1.280	PZ	IP1508A1	POLYSTYREN E U SHAPED PROFILE 2000X60X60	1.270	M	RC1200A0	ED=4 WIRE D.=0.5 COMPRESSIO N SPRING	2	PZ	SL1050A1	3M TRANSFER ADHESIVE TAPE	0.820	M	TB2301A0	RIGHT COLUMN XVC105E 40X40X1	2	PZ	TB3081A0	LMISS ARIANNA/ROS SELLA DOOR LEFT COLUMN	1	PZ	VM1025A0	Ø16 GREY NYLON LID	2	PZ	VM1059A1	HEAT SHRINK FILM H800	1.300	M	VM1695A0	HANDLE POSITION PIN	2	PZ	VM1916A0	RIGHT UPPER COLUMN CAP	1	PZ	VM1917A0	LEFT UPPER COLUMN CAP	1	PZ	VM1918A0	RIGHT LOWER COLUMN CAP	1	PZ	VM1919A0	LEFT LOWER COLUMN CAP	1	PZ	VM1920A0	INTERNAL GLASS CLOSING RIGHT PLATE	1	PZ	VM1921A0	INTERNAL GLASS CLOSING LEFT PLATE	1	PZ	VT1072A0	LINEMISS ROSSELLA BLACK EXTERNAL GLASS				1	PZ
Code	Description	Qty	UOM																																																																													
IP1385A1	CORNER POLYSTYREN E PACKING 110X80X2000	0.960	M																																																																													
IP1508A0		1.280	PZ																																																																													
IP1508A1	POLYSTYREN E U SHAPED PROFILE 2000X60X60	1.270	M																																																																													
RC1200A0	ED=4 WIRE D.=0.5 COMPRESSIO N SPRING	2	PZ																																																																													
SL1050A1	3M TRANSFER ADHESIVE TAPE	0.820	M																																																																													
TB2301A0	RIGHT COLUMN XVC105E 40X40X1	2	PZ																																																																													
TB3081A0	LMISS ARIANNA/ROS SELLA DOOR LEFT COLUMN	1	PZ																																																																													
VM1025A0	Ø16 GREY NYLON LID	2	PZ																																																																													
VM1059A1	HEAT SHRINK FILM H800	1.300	M																																																																													
VM1695A0	HANDLE POSITION PIN	2	PZ																																																																													
VM1916A0	RIGHT UPPER COLUMN CAP	1	PZ																																																																													
VM1917A0	LEFT UPPER COLUMN CAP	1	PZ																																																																													
VM1918A0	RIGHT LOWER COLUMN CAP	1	PZ																																																																													
VM1919A0	LEFT LOWER COLUMN CAP	1	PZ																																																																													
VM1920A0	INTERNAL GLASS CLOSING RIGHT PLATE	1	PZ																																																																													
VM1921A0	INTERNAL GLASS CLOSING LEFT PLATE	1	PZ																																																																													
VT1072A0	LINEMISS ROSSELLA BLACK EXTERNAL GLASS				1	PZ																																																																										

COMPONENT			SPARE PART																														
Code	Description	Image	Code	Description	Components list																												
CR1050A	XVC105/DECK/ROSS ELLA DOOR HINGE		KCR1050A	XVC105/DECK/ROSS ELLA HINGES KIT	<table border="1"> <thead> <tr> <th>Code</th> <th>Description</th> <th>Qty</th> <th>UOM</th> </tr> </thead> <tbody> <tr> <td>CR1050A1</td> <td>XVC105/DECK/ ROSSELLA DOOR HINGE</td> <td>2</td> <td>PZ</td> </tr> <tr> <td>VI1875A0</td> <td>SCREW M5X10 TC1/2T INOX</td> <td>6</td> <td>PZ</td> </tr> </tbody> </table>	Code	Description	Qty	UOM	CR1050A1	XVC105/DECK/ ROSSELLA DOOR HINGE	2	PZ	VI1875A0	SCREW M5X10 TC1/2T INOX	6	PZ																
Code	Description	Qty	UOM																														
CR1050A1	XVC105/DECK/ ROSSELLA DOOR HINGE	2	PZ																														
VI1875A0	SCREW M5X10 TC1/2T INOX	6	PZ																														
OH1930B	HANDLE TUBE L= 718 Ø18X1		KOH1930B	LMISS 800 HANDLE KIT	<table border="1"> <thead> <tr> <th>Code</th> <th>Description</th> <th>Qty</th> <th>UOM</th> </tr> </thead> <tbody> <tr> <td>OH1930B0</td> <td>HANDLE TUBE L= 718 Ø18X1</td> <td>1</td> <td>PZ</td> </tr> <tr> <td>MG1015B0</td> <td>LMISS/LMICR O/CHEFTOP HANDLE END</td> <td>2</td> <td>PZ</td> </tr> <tr> <td>VI1855A0</td> <td>5X25 SELF-TAPPIN G SCREW</td> <td>2</td> <td>PZ</td> </tr> <tr> <td>VM1025A0</td> <td>Ø16 GREY NYLON LID</td> <td>2</td> <td>PZ</td> </tr> <tr> <td>VM1794A0</td> <td>250X4.8 PA66 BLACK CLAMP</td> <td>2</td> <td>PZ</td> </tr> <tr> <td>VM2103A0</td> <td>CLAMP LOCK</td> <td>2</td> <td>PZ</td> </tr> </tbody> </table>	Code	Description	Qty	UOM	OH1930B0	HANDLE TUBE L= 718 Ø18X1	1	PZ	MG1015B0	LMISS/LMICR O/CHEFTOP HANDLE END	2	PZ	VI1855A0	5X25 SELF-TAPPIN G SCREW	2	PZ	VM1025A0	Ø16 GREY NYLON LID	2	PZ	VM1794A0	250X4.8 PA66 BLACK CLAMP	2	PZ	VM2103A0	CLAMP LOCK	2	PZ
Code	Description	Qty	UOM																														
OH1930B0	HANDLE TUBE L= 718 Ø18X1	1	PZ																														
MG1015B0	LMISS/LMICR O/CHEFTOP HANDLE END	2	PZ																														
VI1855A0	5X25 SELF-TAPPIN G SCREW	2	PZ																														
VM1025A0	Ø16 GREY NYLON LID	2	PZ																														
VM1794A0	250X4.8 PA66 BLACK CLAMP	2	PZ																														
VM2103A0	CLAMP LOCK	2	PZ																														
VM1918A	RIGHT LOWER COLUMN CAP		KVM1918A	LMISS 60X40 RIGHT LOWER DOOR COLUMN CAP	<table border="1"> <thead> <tr> <th>Code</th> <th>Description</th> <th>Qty</th> <th>UOM</th> </tr> </thead> <tbody> <tr> <td>VM1918A0</td> <td>RIGHT LOWER COLUMN CAP</td> <td>1</td> <td>PZ</td> </tr> </tbody> </table>	Code	Description	Qty	UOM	VM1918A0	RIGHT LOWER COLUMN CAP	1	PZ																				
Code	Description	Qty	UOM																														
VM1918A0	RIGHT LOWER COLUMN CAP	1	PZ																														
VM1919A	LEFT LOWER COLUMN CAP		KVM1919A	LMISS 60X40 LEFT LOWER DOOR COLUMN CAP	<table border="1"> <thead> <tr> <th>Code</th> <th>Description</th> <th>Qty</th> <th>UOM</th> </tr> </thead> <tbody> <tr> <td>VM1919A0</td> <td>LEFT LOWER COLUMN CAP</td> <td>1</td> <td>PZ</td> </tr> </tbody> </table>	Code	Description	Qty	UOM	VM1919A0	LEFT LOWER COLUMN CAP	1	PZ																				
Code	Description	Qty	UOM																														
VM1919A0	LEFT LOWER COLUMN CAP	1	PZ																														
VM1916A	RIGHT UPPER COLUMN CAP		KVT1253A	XF-XFT195-EG- VT1253A EXTERNAL GLASS KIT	<table border="1"> <thead> <tr> <th>Code</th> <th>Description</th> <th>Qty</th> <th>UOM</th> </tr> </thead> <tbody> <tr> <td>IP1235B0</td> <td>POLYSTYREN E FLAT PACKING</td> <td>1</td> <td>PZ</td> </tr> <tr> <td>RC1200A0</td> <td>ED=4 WIRE D.=0.5 COMPRESSIO N SPRING</td> <td>2</td> <td>PZ</td> </tr> </tbody> </table>	Code	Description	Qty	UOM	IP1235B0	POLYSTYREN E FLAT PACKING	1	PZ	RC1200A0	ED=4 WIRE D.=0.5 COMPRESSIO N SPRING	2	PZ																
Code	Description	Qty	UOM																														
IP1235B0	POLYSTYREN E FLAT PACKING	1	PZ																														
RC1200A0	ED=4 WIRE D.=0.5 COMPRESSIO N SPRING	2	PZ																														



COMPONENT			SPARE PART																																																																																
Code	Description	Image	Code	Description	Components list																																																																														
VM1916A	RIGHT UPPER COLUMN CAP		KVT1253A	XF-XFT195-EG-VT1253A EXTERNAL GLASS KIT	<table border="1"> <thead> <tr> <th>Code</th> <th>Description</th> <th>Qty</th> <th>UOM</th> </tr> </thead> <tbody> <tr> <td>SL1050A1</td> <td>3M TRANSFER ADHESIVE TAPE</td> <td>0.820</td> <td>M</td> </tr> <tr> <td>TB2301A0</td> <td>RIGHT COLUMN XVC105E 40X40X1</td> <td>2</td> <td>PZ</td> </tr> <tr> <td>TB3081A0</td> <td>LMISS ARIANNA/ROS SELLA DOOR LEFT COLUMN</td> <td>1</td> <td>PZ</td> </tr> <tr> <td>VM1025A0</td> <td>Ø16 GREY NYLON LID</td> <td>2</td> <td>PZ</td> </tr> <tr> <td>VM1695A0</td> <td>HANDLE POSITION PIN</td> <td>2</td> <td>PZ</td> </tr> <tr> <td>VM1916A0</td> <td>RIGHT UPPER COLUMN CAP</td> <td>1</td> <td>PZ</td> </tr> <tr> <td>VM1917A0</td> <td>LEFT UPPER COLUMN CAP</td> <td>1</td> <td>PZ</td> </tr> <tr> <td>VM1918A0</td> <td>RIGHT LOWER COLUMN CAP</td> <td>1</td> <td>PZ</td> </tr> <tr> <td>VM1919A0</td> <td>LEFT LOWER COLUMN CAP</td> <td>1</td> <td>PZ</td> </tr> <tr> <td>VM1920A0</td> <td>INTERNAL GLASS CLOSING RIGHT PLATE</td> <td>1</td> <td>PZ</td> </tr> <tr> <td>VM1921A0</td> <td>INTERNAL GLASS CLOSING LEFT PLATE</td> <td>1</td> <td>PZ</td> </tr> <tr> <td></td> <td></td> <td></td> <td>KVT1072A</td> <td>L.M. ROSSELLA BLACK EXTERNAL GLASS KIT</td> <td> <table border="1"> <thead> <tr> <th>Code</th> <th>Description</th> <th>Qty</th> <th>UOM</th> </tr> </thead> <tbody> <tr> <td>IP1385A1</td> <td>CORNER POLYSTYREN E PACKING 110X80X2000</td> <td>0.960</td> <td>M</td> </tr> <tr> <td>IP1508A0</td> <td></td> <td>1.280</td> <td>PZ</td> </tr> <tr> <td>IP1508A1</td> <td>POLYSTYREN E U SHAPED PROFILE 2000X60X60</td> <td>1.270</td> <td>M</td> </tr> <tr> <td>RC1200A0</td> <td>ED=4 WIRE D.=0.5 COMPRESSIO N SPRING</td> <td>2</td> <td>PZ</td> </tr> <tr> <td>SL1050A1</td> <td>3M TRANSFER ADHESIVE TAPE</td> <td>0.820</td> <td>M</td> </tr> </tbody> </table> </td> </tr> </tbody> </table>	Code	Description	Qty	UOM	SL1050A1	3M TRANSFER ADHESIVE TAPE	0.820	M	TB2301A0	RIGHT COLUMN XVC105E 40X40X1	2	PZ	TB3081A0	LMISS ARIANNA/ROS SELLA DOOR LEFT COLUMN	1	PZ	VM1025A0	Ø16 GREY NYLON LID	2	PZ	VM1695A0	HANDLE POSITION PIN	2	PZ	VM1916A0	RIGHT UPPER COLUMN CAP	1	PZ	VM1917A0	LEFT UPPER COLUMN CAP	1	PZ	VM1918A0	RIGHT LOWER COLUMN CAP	1	PZ	VM1919A0	LEFT LOWER COLUMN CAP	1	PZ	VM1920A0	INTERNAL GLASS CLOSING RIGHT PLATE	1	PZ	VM1921A0	INTERNAL GLASS CLOSING LEFT PLATE	1	PZ				KVT1072A	L.M. ROSSELLA BLACK EXTERNAL GLASS KIT	<table border="1"> <thead> <tr> <th>Code</th> <th>Description</th> <th>Qty</th> <th>UOM</th> </tr> </thead> <tbody> <tr> <td>IP1385A1</td> <td>CORNER POLYSTYREN E PACKING 110X80X2000</td> <td>0.960</td> <td>M</td> </tr> <tr> <td>IP1508A0</td> <td></td> <td>1.280</td> <td>PZ</td> </tr> <tr> <td>IP1508A1</td> <td>POLYSTYREN E U SHAPED PROFILE 2000X60X60</td> <td>1.270</td> <td>M</td> </tr> <tr> <td>RC1200A0</td> <td>ED=4 WIRE D.=0.5 COMPRESSIO N SPRING</td> <td>2</td> <td>PZ</td> </tr> <tr> <td>SL1050A1</td> <td>3M TRANSFER ADHESIVE TAPE</td> <td>0.820</td> <td>M</td> </tr> </tbody> </table>	Code	Description	Qty	UOM	IP1385A1	CORNER POLYSTYREN E PACKING 110X80X2000	0.960	M	IP1508A0		1.280	PZ	IP1508A1	POLYSTYREN E U SHAPED PROFILE 2000X60X60	1.270	M	RC1200A0	ED=4 WIRE D.=0.5 COMPRESSIO N SPRING	2	PZ	SL1050A1	3M TRANSFER ADHESIVE TAPE	0.820	M
			Code	Description	Qty	UOM																																																																													
SL1050A1	3M TRANSFER ADHESIVE TAPE	0.820	M																																																																																
TB2301A0	RIGHT COLUMN XVC105E 40X40X1	2	PZ																																																																																
TB3081A0	LMISS ARIANNA/ROS SELLA DOOR LEFT COLUMN	1	PZ																																																																																
VM1025A0	Ø16 GREY NYLON LID	2	PZ																																																																																
VM1695A0	HANDLE POSITION PIN	2	PZ																																																																																
VM1916A0	RIGHT UPPER COLUMN CAP	1	PZ																																																																																
VM1917A0	LEFT UPPER COLUMN CAP	1	PZ																																																																																
VM1918A0	RIGHT LOWER COLUMN CAP	1	PZ																																																																																
VM1919A0	LEFT LOWER COLUMN CAP	1	PZ																																																																																
VM1920A0	INTERNAL GLASS CLOSING RIGHT PLATE	1	PZ																																																																																
VM1921A0	INTERNAL GLASS CLOSING LEFT PLATE	1	PZ																																																																																
			KVT1072A	L.M. ROSSELLA BLACK EXTERNAL GLASS KIT	<table border="1"> <thead> <tr> <th>Code</th> <th>Description</th> <th>Qty</th> <th>UOM</th> </tr> </thead> <tbody> <tr> <td>IP1385A1</td> <td>CORNER POLYSTYREN E PACKING 110X80X2000</td> <td>0.960</td> <td>M</td> </tr> <tr> <td>IP1508A0</td> <td></td> <td>1.280</td> <td>PZ</td> </tr> <tr> <td>IP1508A1</td> <td>POLYSTYREN E U SHAPED PROFILE 2000X60X60</td> <td>1.270</td> <td>M</td> </tr> <tr> <td>RC1200A0</td> <td>ED=4 WIRE D.=0.5 COMPRESSIO N SPRING</td> <td>2</td> <td>PZ</td> </tr> <tr> <td>SL1050A1</td> <td>3M TRANSFER ADHESIVE TAPE</td> <td>0.820</td> <td>M</td> </tr> </tbody> </table>	Code	Description	Qty	UOM	IP1385A1	CORNER POLYSTYREN E PACKING 110X80X2000	0.960	M	IP1508A0		1.280	PZ	IP1508A1	POLYSTYREN E U SHAPED PROFILE 2000X60X60	1.270	M	RC1200A0	ED=4 WIRE D.=0.5 COMPRESSIO N SPRING	2	PZ	SL1050A1	3M TRANSFER ADHESIVE TAPE	0.820	M																																																						
Code	Description	Qty	UOM																																																																																
IP1385A1	CORNER POLYSTYREN E PACKING 110X80X2000	0.960	M																																																																																
IP1508A0		1.280	PZ																																																																																
IP1508A1	POLYSTYREN E U SHAPED PROFILE 2000X60X60	1.270	M																																																																																
RC1200A0	ED=4 WIRE D.=0.5 COMPRESSIO N SPRING	2	PZ																																																																																
SL1050A1	3M TRANSFER ADHESIVE TAPE	0.820	M																																																																																





COMPONENT			SPARE PART																																																						
Code	Description	Image	Code	Description	Components list																																																				
VM1916A	RIGHT UPPER COLUMN CAP		KVT1072A	L.M. ROSSELLA BLACK EXTERNAL GLASS KIT	<table border="1"> <thead> <tr> <th>Code</th> <th>Description</th> <th>Qty</th> <th>UOM</th> </tr> </thead> <tbody> <tr> <td>TB2301A0</td> <td>RIGHT COLUMN XVC105E 40X40X1</td> <td>2</td> <td>PZ</td> </tr> <tr> <td>TB3081A0</td> <td>LMISS ARIANNA/ROS SELLA DOOR LEFT COLUMN</td> <td>1</td> <td>PZ</td> </tr> <tr> <td>VM1025A0</td> <td>Ø16 GREY NYLON LID</td> <td>2</td> <td>PZ</td> </tr> <tr> <td>VM1059A1</td> <td>HEAT SHRINK FILM H800</td> <td>1.300</td> <td>M</td> </tr> <tr> <td>VM1695A0</td> <td>HANDLE POSITION PIN</td> <td>2</td> <td>PZ</td> </tr> <tr> <td>VM1916A0</td> <td>RIGHT UPPER COLUMN CAP</td> <td>1</td> <td>PZ</td> </tr> <tr> <td>VM1917A0</td> <td>LEFT UPPER COLUMN CAP</td> <td>1</td> <td>PZ</td> </tr> <tr> <td>VM1918A0</td> <td>RIGHT LOWER COLUMN CAP</td> <td>1</td> <td>PZ</td> </tr> <tr> <td>VM1919A0</td> <td>LEFT LOWER COLUMN CAP</td> <td>1</td> <td>PZ</td> </tr> <tr> <td>VM1920A0</td> <td>INTERNAL GLASS CLOSING RIGHT PLATE</td> <td>1</td> <td>PZ</td> </tr> <tr> <td>VM1921A0</td> <td>INTERNAL GLASS CLOSING LEFT PLATE</td> <td>1</td> <td>PZ</td> </tr> <tr> <td>VT1072A0</td> <td>LINEMISS ROSSELLA BLACK EXTERNAL GLASS</td> <td>1</td> <td>PZ</td> </tr> </tbody> </table>	Code	Description	Qty	UOM	TB2301A0	RIGHT COLUMN XVC105E 40X40X1	2	PZ	TB3081A0	LMISS ARIANNA/ROS SELLA DOOR LEFT COLUMN	1	PZ	VM1025A0	Ø16 GREY NYLON LID	2	PZ	VM1059A1	HEAT SHRINK FILM H800	1.300	M	VM1695A0	HANDLE POSITION PIN	2	PZ	VM1916A0	RIGHT UPPER COLUMN CAP	1	PZ	VM1917A0	LEFT UPPER COLUMN CAP	1	PZ	VM1918A0	RIGHT LOWER COLUMN CAP	1	PZ	VM1919A0	LEFT LOWER COLUMN CAP	1	PZ	VM1920A0	INTERNAL GLASS CLOSING RIGHT PLATE	1	PZ	VM1921A0	INTERNAL GLASS CLOSING LEFT PLATE	1	PZ	VT1072A0	LINEMISS ROSSELLA BLACK EXTERNAL GLASS	1	PZ
			Code	Description	Qty	UOM																																																			
TB2301A0	RIGHT COLUMN XVC105E 40X40X1	2	PZ																																																						
TB3081A0	LMISS ARIANNA/ROS SELLA DOOR LEFT COLUMN	1	PZ																																																						
VM1025A0	Ø16 GREY NYLON LID	2	PZ																																																						
VM1059A1	HEAT SHRINK FILM H800	1.300	M																																																						
VM1695A0	HANDLE POSITION PIN	2	PZ																																																						
VM1916A0	RIGHT UPPER COLUMN CAP	1	PZ																																																						
VM1917A0	LEFT UPPER COLUMN CAP	1	PZ																																																						
VM1918A0	RIGHT LOWER COLUMN CAP	1	PZ																																																						
VM1919A0	LEFT LOWER COLUMN CAP	1	PZ																																																						
VM1920A0	INTERNAL GLASS CLOSING RIGHT PLATE	1	PZ																																																						
VM1921A0	INTERNAL GLASS CLOSING LEFT PLATE	1	PZ																																																						
VT1072A0	LINEMISS ROSSELLA BLACK EXTERNAL GLASS	1	PZ																																																						
KVT1071A	L.M. ROSSELLA EXTERNAL GLASS KIT	<table border="1"> <thead> <tr> <th>Code</th> <th>Description</th> <th>Qty</th> <th>UOM</th> </tr> </thead> <tbody> <tr> <td>IP1385A1</td> <td>CORNER POLYSTYREN E PACKING 110X80X2000</td> <td>0.960</td> <td>M</td> </tr> <tr> <td>IP1508A0</td> <td></td> <td>1.300</td> <td>PZ</td> </tr> <tr> <td>IP1508A1</td> <td>POLYSTYREN E U SHAPED PROFILE 2000X60X60</td> <td>2</td> <td>M</td> </tr> <tr> <td>RC1200A0</td> <td>ED=4 WIRE D.=0.5 COMPRESSIO N SPRING</td> <td>2</td> <td>PZ</td> </tr> <tr> <td>SL1050A1</td> <td>3M TRANSFER ADHESIVE TAPE</td> <td>0.820</td> <td>M</td> </tr> </tbody> </table>	Code	Description	Qty	UOM	IP1385A1	CORNER POLYSTYREN E PACKING 110X80X2000	0.960	M	IP1508A0		1.300	PZ	IP1508A1	POLYSTYREN E U SHAPED PROFILE 2000X60X60	2	M	RC1200A0	ED=4 WIRE D.=0.5 COMPRESSIO N SPRING	2	PZ	SL1050A1	3M TRANSFER ADHESIVE TAPE	0.820	M																															
Code	Description	Qty	UOM																																																						
IP1385A1	CORNER POLYSTYREN E PACKING 110X80X2000	0.960	M																																																						
IP1508A0		1.300	PZ																																																						
IP1508A1	POLYSTYREN E U SHAPED PROFILE 2000X60X60	2	M																																																						
RC1200A0	ED=4 WIRE D.=0.5 COMPRESSIO N SPRING	2	PZ																																																						
SL1050A1	3M TRANSFER ADHESIVE TAPE	0.820	M																																																						

COMPONENT			SPARE PART																																																		
Code	Description	Image	Code	Description	Components list																																																
VM1916A	RIGHT UPPER COLUMN CAP		KVT1071A	L.M. ROSSELLA EXTERNAL GLASS KIT	<table border="1"> <thead> <tr> <th>Code</th> <th>Description</th> <th>Qty</th> <th>UOM</th> </tr> </thead> <tbody> <tr> <td>TB2301A0</td> <td>RIGHT COLUMN XVC105E 40X40X1</td> <td>2</td> <td>PZ</td> </tr> <tr> <td>VM1025A0</td> <td>Ø16 GREY NYLON LID</td> <td>2</td> <td>PZ</td> </tr> <tr> <td>VM1059A1</td> <td>HEAT SHRINK FILM H800</td> <td>1.350</td> <td>M</td> </tr> <tr> <td>VM1695A0</td> <td>HANDLE POSITION PIN</td> <td>2</td> <td>PZ</td> </tr> <tr> <td>VM1916A0</td> <td>RIGHT UPPER COLUMN CAP</td> <td>1</td> <td>PZ</td> </tr> <tr> <td>VM1917A0</td> <td>LEFT UPPER COLUMN CAP</td> <td>1</td> <td>PZ</td> </tr> <tr> <td>VM1918A0</td> <td>RIGHT LOWER COLUMN CAP</td> <td>1</td> <td>PZ</td> </tr> <tr> <td>VM1919A0</td> <td>LEFT LOWER COLUMN CAP</td> <td>1</td> <td>PZ</td> </tr> <tr> <td>VM1920A0</td> <td>INTERNAL GLASS CLOSING RIGHT PLATE</td> <td>1</td> <td>PZ</td> </tr> <tr> <td>VM1921A0</td> <td>INTERNAL GLASS CLOSING LEFT PLATE</td> <td>1</td> <td>PZ</td> </tr> <tr> <td>VT1071A2</td> <td>YELLOW SER GLASS 798X424X5</td> <td>1</td> <td>PZ</td> </tr> </tbody> </table>	Code	Description	Qty	UOM	TB2301A0	RIGHT COLUMN XVC105E 40X40X1	2	PZ	VM1025A0	Ø16 GREY NYLON LID	2	PZ	VM1059A1	HEAT SHRINK FILM H800	1.350	M	VM1695A0	HANDLE POSITION PIN	2	PZ	VM1916A0	RIGHT UPPER COLUMN CAP	1	PZ	VM1917A0	LEFT UPPER COLUMN CAP	1	PZ	VM1918A0	RIGHT LOWER COLUMN CAP	1	PZ	VM1919A0	LEFT LOWER COLUMN CAP	1	PZ	VM1920A0	INTERNAL GLASS CLOSING RIGHT PLATE	1	PZ	VM1921A0	INTERNAL GLASS CLOSING LEFT PLATE	1	PZ	VT1071A2	YELLOW SER GLASS 798X424X5	1	PZ
			Code	Description	Qty	UOM																																															
TB2301A0	RIGHT COLUMN XVC105E 40X40X1	2	PZ																																																		
VM1025A0	Ø16 GREY NYLON LID	2	PZ																																																		
VM1059A1	HEAT SHRINK FILM H800	1.350	M																																																		
VM1695A0	HANDLE POSITION PIN	2	PZ																																																		
VM1916A0	RIGHT UPPER COLUMN CAP	1	PZ																																																		
VM1917A0	LEFT UPPER COLUMN CAP	1	PZ																																																		
VM1918A0	RIGHT LOWER COLUMN CAP	1	PZ																																																		
VM1919A0	LEFT LOWER COLUMN CAP	1	PZ																																																		
VM1920A0	INTERNAL GLASS CLOSING RIGHT PLATE	1	PZ																																																		
VM1921A0	INTERNAL GLASS CLOSING LEFT PLATE	1	PZ																																																		
VT1071A2	YELLOW SER GLASS 798X424X5	1	PZ																																																		
KVT1067A	L.M. ELENA BLACK EXTERNAL GLASS KIT	<table border="1"> <thead> <tr> <th>Code</th> <th>Description</th> <th>Qty</th> <th>UOM</th> </tr> </thead> <tbody> <tr> <td>IP1385A1</td> <td>CORNER POLYSTYREN E PACKING 110X80X2000</td> <td>0.800</td> <td>M</td> </tr> <tr> <td>IP1508A0</td> <td></td> <td>1.710</td> <td>PZ</td> </tr> <tr> <td>IP1508A1</td> <td>POLYSTYREN E U SHAPED PROFILE 2000X60X60</td> <td>2</td> <td>M</td> </tr> <tr> <td>RC1200A0</td> <td>ED=4 WIRE D.=0.5 COMPRESSIO N SPRING</td> <td>2</td> <td>PZ</td> </tr> <tr> <td>SL1050A1</td> <td>3M TRANSFER ADHESIVE TAPE</td> <td>0.660</td> <td>M</td> </tr> <tr> <td>TB2306A0</td> <td>LMISS STEFANIA/ELE NA DOOR RIGHT COLUM</td> <td>2</td> <td>PZ</td> </tr> <tr> <td>TB3080A0</td> <td>LMISS STEFANIA/ELE NA DOOR LEFT COLUMN</td> <td>1</td> <td>PZ</td> </tr> </tbody> </table>	Code	Description	Qty	UOM	IP1385A1	CORNER POLYSTYREN E PACKING 110X80X2000	0.800	M	IP1508A0		1.710	PZ	IP1508A1	POLYSTYREN E U SHAPED PROFILE 2000X60X60	2	M	RC1200A0	ED=4 WIRE D.=0.5 COMPRESSIO N SPRING	2	PZ	SL1050A1	3M TRANSFER ADHESIVE TAPE	0.660	M	TB2306A0	LMISS STEFANIA/ELE NA DOOR RIGHT COLUM	2	PZ	TB3080A0	LMISS STEFANIA/ELE NA DOOR LEFT COLUMN	1	PZ																			
Code	Description	Qty	UOM																																																		
IP1385A1	CORNER POLYSTYREN E PACKING 110X80X2000	0.800	M																																																		
IP1508A0		1.710	PZ																																																		
IP1508A1	POLYSTYREN E U SHAPED PROFILE 2000X60X60	2	M																																																		
RC1200A0	ED=4 WIRE D.=0.5 COMPRESSIO N SPRING	2	PZ																																																		
SL1050A1	3M TRANSFER ADHESIVE TAPE	0.660	M																																																		
TB2306A0	LMISS STEFANIA/ELE NA DOOR RIGHT COLUM	2	PZ																																																		
TB3080A0	LMISS STEFANIA/ELE NA DOOR LEFT COLUMN	1	PZ																																																		

COMPONENT			SPARE PART																																														
Code	Description	Image	Code	Description	Components list																																												
VM1916A	RIGHT UPPER COLUMN CAP		KVT1067A	L.M. ELENA BLACK EXTERNAL GLASS KIT	<table border="1"> <thead> <tr> <th>Code</th> <th>Description</th> <th>Qty</th> <th>UOM</th> </tr> </thead> <tbody> <tr> <td>VM1025A0</td> <td>Ø16 GREY NYLON LID</td> <td>2</td> <td>PZ</td> </tr> <tr> <td>VM1059A1</td> <td>HEAT SHRINK FILM H800</td> <td>1.350</td> <td>M</td> </tr> <tr> <td>VM1695A0</td> <td>HANDLE POSITION PIN</td> <td>2</td> <td>PZ</td> </tr> <tr> <td>VM1916A0</td> <td>RIGHT UPPER COLUMN CAP</td> <td>1</td> <td>PZ</td> </tr> <tr> <td>VM1917A0</td> <td>LEFT UPPER COLUMN CAP</td> <td>1</td> <td>PZ</td> </tr> <tr> <td>VM1918A0</td> <td>RIGHT LOWER COLUMN CAP</td> <td>1</td> <td>PZ</td> </tr> <tr> <td>VM1919A0</td> <td>LEFT LOWER COLUMN CAP</td> <td>1</td> <td>PZ</td> </tr> <tr> <td>VM1920A0</td> <td>INTERNAL GLASS CLOSING RIGHT PLATE</td> <td>1</td> <td>PZ</td> </tr> <tr> <td>VM1921A0</td> <td>INTERNAL GLASS CLOSING LEFT PLATE</td> <td>1</td> <td>PZ</td> </tr> <tr> <td>VT1067A0</td> <td>LINEMISS ELENA BLACK EXTERNAL DOOR GLASS</td> <td>1</td> <td>PZ</td> </tr> </tbody> </table>	Code	Description	Qty	UOM	VM1025A0	Ø16 GREY NYLON LID	2	PZ	VM1059A1	HEAT SHRINK FILM H800	1.350	M	VM1695A0	HANDLE POSITION PIN	2	PZ	VM1916A0	RIGHT UPPER COLUMN CAP	1	PZ	VM1917A0	LEFT UPPER COLUMN CAP	1	PZ	VM1918A0	RIGHT LOWER COLUMN CAP	1	PZ	VM1919A0	LEFT LOWER COLUMN CAP	1	PZ	VM1920A0	INTERNAL GLASS CLOSING RIGHT PLATE	1	PZ	VM1921A0	INTERNAL GLASS CLOSING LEFT PLATE	1	PZ	VT1067A0	LINEMISS ELENA BLACK EXTERNAL DOOR GLASS	1	PZ
			Code	Description	Qty	UOM																																											
VM1025A0	Ø16 GREY NYLON LID	2	PZ																																														
VM1059A1	HEAT SHRINK FILM H800	1.350	M																																														
VM1695A0	HANDLE POSITION PIN	2	PZ																																														
VM1916A0	RIGHT UPPER COLUMN CAP	1	PZ																																														
VM1917A0	LEFT UPPER COLUMN CAP	1	PZ																																														
VM1918A0	RIGHT LOWER COLUMN CAP	1	PZ																																														
VM1919A0	LEFT LOWER COLUMN CAP	1	PZ																																														
VM1920A0	INTERNAL GLASS CLOSING RIGHT PLATE	1	PZ																																														
VM1921A0	INTERNAL GLASS CLOSING LEFT PLATE	1	PZ																																														
VT1067A0	LINEMISS ELENA BLACK EXTERNAL DOOR GLASS	1	PZ																																														
KVT1066A	L.M. ELENA EXTERNAL GLASS KIT	<table border="1"> <thead> <tr> <th>Code</th> <th>Description</th> <th>Qty</th> <th>UOM</th> </tr> </thead> <tbody> <tr> <td>IP1385A1</td> <td>CORNER POLYSTYREN E PACKING 110X80X2000</td> <td>0.800</td> <td>M</td> </tr> <tr> <td>IP1508A0</td> <td></td> <td>1.710</td> <td>PZ</td> </tr> <tr> <td>IP1508A1</td> <td>POLYSTYREN E U SHAPED PROFILE 2000X60X60</td> <td>2</td> <td>M</td> </tr> <tr> <td>RC1200A0</td> <td>ED=4 WIRE D.=0.5 COMPRESSIO N SPRING</td> <td>2</td> <td>PZ</td> </tr> <tr> <td>SL1050A1</td> <td>3M TRANSFER ADHESIVE TAPE</td> <td>0.660</td> <td>M</td> </tr> <tr> <td>TB2306A0</td> <td>LMISS STEFANIA/ELE NA DOOR RIGHT COLUM</td> <td>2</td> <td>PZ</td> </tr> <tr> <td>VM1025A0</td> <td>Ø16 GREY NYLON LID</td> <td>2</td> <td>PZ</td> </tr> <tr> <td>VM1059A1</td> <td>HEAT SHRINK FILM H800</td> <td>1.350</td> <td>M</td> </tr> <tr> <td>VM1695A0</td> <td>HANDLE POSITION PIN</td> <td>2</td> <td>PZ</td> </tr> <tr> <td>VM1916A0</td> <td>RIGHT UPPER COLUMN CAP</td> <td>1</td> <td>PZ</td> </tr> </tbody> </table>	Code	Description	Qty	UOM	IP1385A1	CORNER POLYSTYREN E PACKING 110X80X2000	0.800	M	IP1508A0		1.710	PZ	IP1508A1	POLYSTYREN E U SHAPED PROFILE 2000X60X60	2	M	RC1200A0	ED=4 WIRE D.=0.5 COMPRESSIO N SPRING	2	PZ	SL1050A1	3M TRANSFER ADHESIVE TAPE	0.660	M	TB2306A0	LMISS STEFANIA/ELE NA DOOR RIGHT COLUM	2	PZ	VM1025A0	Ø16 GREY NYLON LID	2	PZ	VM1059A1	HEAT SHRINK FILM H800	1.350	M	VM1695A0	HANDLE POSITION PIN	2	PZ	VM1916A0	RIGHT UPPER COLUMN CAP	1	PZ			
Code	Description	Qty	UOM																																														
IP1385A1	CORNER POLYSTYREN E PACKING 110X80X2000	0.800	M																																														
IP1508A0		1.710	PZ																																														
IP1508A1	POLYSTYREN E U SHAPED PROFILE 2000X60X60	2	M																																														
RC1200A0	ED=4 WIRE D.=0.5 COMPRESSIO N SPRING	2	PZ																																														
SL1050A1	3M TRANSFER ADHESIVE TAPE	0.660	M																																														
TB2306A0	LMISS STEFANIA/ELE NA DOOR RIGHT COLUM	2	PZ																																														
VM1025A0	Ø16 GREY NYLON LID	2	PZ																																														
VM1059A1	HEAT SHRINK FILM H800	1.350	M																																														
VM1695A0	HANDLE POSITION PIN	2	PZ																																														
VM1916A0	RIGHT UPPER COLUMN CAP	1	PZ																																														

COMPONENT			SPARE PART																																																		
Code	Description	Image	Code	Description	Components list																																																
VM1916A	RIGHT UPPER COLUMN CAP		KVT1066A	L.M. ELENA EXTERNAL GLASS KIT	<table border="1"> <thead> <tr> <th>Code</th> <th>Description</th> <th>Qty</th> <th>UOM</th> </tr> </thead> <tbody> <tr> <td>VM1917A0</td> <td>LEFT UPPER COLUMN CAP</td> <td>1</td> <td>PZ</td> </tr> <tr> <td>VM1918A0</td> <td>RIGHT LOWER COLUMN CAP</td> <td>1</td> <td>PZ</td> </tr> <tr> <td>VM1919A0</td> <td>LEFT LOWER COLUMN CAP</td> <td>1</td> <td>PZ</td> </tr> <tr> <td>VM1920A0</td> <td>INTERNAL GLASS CLOSING RIGHT PLATE</td> <td>1</td> <td>PZ</td> </tr> <tr> <td>VM1921A0</td> <td>INTERNAL GLASS CLOSING LEFT PLATE</td> <td>1</td> <td>PZ</td> </tr> <tr> <td>VT1066A2</td> <td>YELLOW SER GLASS 798X344X5</td> <td>1</td> <td>PZ</td> </tr> </tbody> </table>	Code	Description	Qty	UOM	VM1917A0	LEFT UPPER COLUMN CAP	1	PZ	VM1918A0	RIGHT LOWER COLUMN CAP	1	PZ	VM1919A0	LEFT LOWER COLUMN CAP	1	PZ	VM1920A0	INTERNAL GLASS CLOSING RIGHT PLATE	1	PZ	VM1921A0	INTERNAL GLASS CLOSING LEFT PLATE	1	PZ	VT1066A2	YELLOW SER GLASS 798X344X5	1	PZ																				
			Code	Description	Qty	UOM																																															
VM1917A0	LEFT UPPER COLUMN CAP	1	PZ																																																		
VM1918A0	RIGHT LOWER COLUMN CAP	1	PZ																																																		
VM1919A0	LEFT LOWER COLUMN CAP	1	PZ																																																		
VM1920A0	INTERNAL GLASS CLOSING RIGHT PLATE	1	PZ																																																		
VM1921A0	INTERNAL GLASS CLOSING LEFT PLATE	1	PZ																																																		
VT1066A2	YELLOW SER GLASS 798X344X5	1	PZ																																																		
KVM1916A	LMISS 60X40 RIGHT UPPER DOOR	<table border="1"> <thead> <tr> <th>Code</th> <th>Description</th> <th>Qty</th> <th>UOM</th> </tr> </thead> <tbody> <tr> <td>VM1916A0</td> <td>RIGHT UPPER COLUMN CAP</td> <td>1</td> <td>PZ</td> </tr> </tbody> </table>	Code	Description	Qty	UOM	VM1916A0	RIGHT UPPER COLUMN CAP	1	PZ																																											
Code	Description	Qty	UOM																																																		
VM1916A0	RIGHT UPPER COLUMN CAP	1	PZ																																																		
VM1920A	INTERNAL GLASS CLOSING RIGHT PLATE		KVT1253A	COLUMN CAP XF-XFT195-EG-VT1253A EXTERNAL GLASS KIT	<table border="1"> <thead> <tr> <th>Code</th> <th>Description</th> <th>Qty</th> <th>UOM</th> </tr> </thead> <tbody> <tr> <td>IP1235B0</td> <td>POLYSTYREN E FLAT PACKING</td> <td>1</td> <td>PZ</td> </tr> <tr> <td>RC1200A0</td> <td>ED=4 WIRE D.=0.5 COMPRESSIO N SPRING</td> <td>2</td> <td>PZ</td> </tr> <tr> <td>SL1050A1</td> <td>3M TRANSFER ADHESIVE TAPE</td> <td>0.820</td> <td>M</td> </tr> <tr> <td>TB2301A0</td> <td>RIGHT COLUMN XVC105E 40X40X1</td> <td>2</td> <td>PZ</td> </tr> <tr> <td>TB3081A0</td> <td>LMISS ARIANNA/ROS SELLA DOOR LEFT COLUMN</td> <td>1</td> <td>PZ</td> </tr> <tr> <td>VM1025A0</td> <td>Ø16 GREY NYLON LID</td> <td>2</td> <td>PZ</td> </tr> <tr> <td>VM1695A0</td> <td>HANDLE POSITION PIN</td> <td>2</td> <td>PZ</td> </tr> <tr> <td>VM1916A0</td> <td>RIGHT UPPER COLUMN CAP</td> <td>1</td> <td>PZ</td> </tr> <tr> <td>VM1917A0</td> <td>LEFT UPPER COLUMN CAP</td> <td>1</td> <td>PZ</td> </tr> <tr> <td>VM1918A0</td> <td>RIGHT LOWER COLUMN CAP</td> <td>1</td> <td>PZ</td> </tr> <tr> <td>VM1919A0</td> <td>LEFT LOWER COLUMN CAP</td> <td>1</td> <td>PZ</td> </tr> </tbody> </table>	Code	Description	Qty	UOM	IP1235B0	POLYSTYREN E FLAT PACKING	1	PZ	RC1200A0	ED=4 WIRE D.=0.5 COMPRESSIO N SPRING	2	PZ	SL1050A1	3M TRANSFER ADHESIVE TAPE	0.820	M	TB2301A0	RIGHT COLUMN XVC105E 40X40X1	2	PZ	TB3081A0	LMISS ARIANNA/ROS SELLA DOOR LEFT COLUMN	1	PZ	VM1025A0	Ø16 GREY NYLON LID	2	PZ	VM1695A0	HANDLE POSITION PIN	2	PZ	VM1916A0	RIGHT UPPER COLUMN CAP	1	PZ	VM1917A0	LEFT UPPER COLUMN CAP	1	PZ	VM1918A0	RIGHT LOWER COLUMN CAP	1	PZ	VM1919A0	LEFT LOWER COLUMN CAP	1	PZ
Code	Description	Qty	UOM																																																		
IP1235B0	POLYSTYREN E FLAT PACKING	1	PZ																																																		
RC1200A0	ED=4 WIRE D.=0.5 COMPRESSIO N SPRING	2	PZ																																																		
SL1050A1	3M TRANSFER ADHESIVE TAPE	0.820	M																																																		
TB2301A0	RIGHT COLUMN XVC105E 40X40X1	2	PZ																																																		
TB3081A0	LMISS ARIANNA/ROS SELLA DOOR LEFT COLUMN	1	PZ																																																		
VM1025A0	Ø16 GREY NYLON LID	2	PZ																																																		
VM1695A0	HANDLE POSITION PIN	2	PZ																																																		
VM1916A0	RIGHT UPPER COLUMN CAP	1	PZ																																																		
VM1917A0	LEFT UPPER COLUMN CAP	1	PZ																																																		
VM1918A0	RIGHT LOWER COLUMN CAP	1	PZ																																																		
VM1919A0	LEFT LOWER COLUMN CAP	1	PZ																																																		

COMPONENT			SPARE PART																																															
Code	Description	Image	Code	Description	Components list																																													
VM1920A	INTERNAL GLASS CLOSING RIGHT PLATE		KVT1253A	XF-XFT195-EG- VT1253A EXTERNAL GLASS KIT	<table border="1"> <thead> <tr> <th>Code</th> <th>Description</th> <th>Qty</th> <th>UOM</th> </tr> </thead> <tbody> <tr> <td>VM1920A0</td> <td>INTERNAL GLASS CLOSING RIGHT PLATE</td> <td>1</td> <td>PZ</td> </tr> <tr> <td>VM1921A0</td> <td>INTERNAL GLASS CLOSING LEFT PLATE</td> <td>1</td> <td>PZ</td> </tr> <tr> <td>VT1253A0</td> <td>XF-XFT195 DOOR EXT. BLACK GLASS-ENGEF OOD</td> <td>1</td> <td>PZ</td> </tr> </tbody> </table>	Code	Description	Qty	UOM	VM1920A0	INTERNAL GLASS CLOSING RIGHT PLATE	1	PZ	VM1921A0	INTERNAL GLASS CLOSING LEFT PLATE	1	PZ	VT1253A0	XF-XFT195 DOOR EXT. BLACK GLASS-ENGEF OOD	1	PZ																													
			Code	Description	Qty	UOM																																												
VM1920A0	INTERNAL GLASS CLOSING RIGHT PLATE	1	PZ																																															
VM1921A0	INTERNAL GLASS CLOSING LEFT PLATE	1	PZ																																															
VT1253A0	XF-XFT195 DOOR EXT. BLACK GLASS-ENGEF OOD	1	PZ																																															
KVT1252A	XF135-EG- VT1252A EXTERNAL GLASS KIT	<table border="1"> <thead> <tr> <th>Code</th> <th>Description</th> <th>Qty</th> <th>UOM</th> </tr> </thead> <tbody> <tr> <td>RC1200A0</td> <td>ED=4 WIRE D.=0.5 COMPRESSIO N SPRING</td> <td>2</td> <td>PZ</td> </tr> <tr> <td>SL1050A1</td> <td>3M TRANSFER ADHESIVE TAPE</td> <td>0.820</td> <td>M</td> </tr> <tr> <td>TB2301A0</td> <td>RIGHT COLUMN XVC105E 40X40X1</td> <td>2</td> <td>PZ</td> </tr> <tr> <td>TB3081A0</td> <td>LMISS ARIANNA/ROS SELLA DOOR LEFT COLUMN</td> <td>1</td> <td>PZ</td> </tr> <tr> <td>VM1025A0</td> <td>Ø16 GREY NYLON LID</td> <td>2</td> <td>PZ</td> </tr> <tr> <td>VM1695A0</td> <td>HANDLE POSITION PIN</td> <td>2</td> <td>PZ</td> </tr> <tr> <td>VM1920A0</td> <td>INTERNAL GLASS CLOSING RIGHT PLATE</td> <td>1</td> <td>PZ</td> </tr> <tr> <td>VM1921A0</td> <td>INTERNAL GLASS CLOSING LEFT PLATE</td> <td>1</td> <td>PZ</td> </tr> <tr> <td>VM2062A0</td> <td>L.MISS 46X33 RIGHT UPPER DOOR COLUMN CAP</td> <td>1</td> <td>PZ</td> </tr> <tr> <td>VM2063A0</td> <td>L.MISS 46X33 LEFT UPPER DOOR COLUMN CAP</td> <td>1</td> <td>PZ</td> </tr> <tr> <td>VM2064A0</td> <td>L.MISS 46X33 RIGHT LOWER DOOR COLUMN CAP</td> <td>1</td> <td>PZ</td> </tr> </tbody> </table>	Code	Description	Qty	UOM	RC1200A0	ED=4 WIRE D.=0.5 COMPRESSIO N SPRING	2	PZ	SL1050A1	3M TRANSFER ADHESIVE TAPE	0.820	M	TB2301A0	RIGHT COLUMN XVC105E 40X40X1	2	PZ	TB3081A0	LMISS ARIANNA/ROS SELLA DOOR LEFT COLUMN	1	PZ	VM1025A0	Ø16 GREY NYLON LID	2	PZ	VM1695A0	HANDLE POSITION PIN	2	PZ	VM1920A0	INTERNAL GLASS CLOSING RIGHT PLATE	1	PZ	VM1921A0	INTERNAL GLASS CLOSING LEFT PLATE	1	PZ	VM2062A0	L.MISS 46X33 RIGHT UPPER DOOR COLUMN CAP	1	PZ	VM2063A0	L.MISS 46X33 LEFT UPPER DOOR COLUMN CAP	1	PZ	VM2064A0	L.MISS 46X33 RIGHT LOWER DOOR COLUMN CAP	1	PZ
Code	Description	Qty	UOM																																															
RC1200A0	ED=4 WIRE D.=0.5 COMPRESSIO N SPRING	2	PZ																																															
SL1050A1	3M TRANSFER ADHESIVE TAPE	0.820	M																																															
TB2301A0	RIGHT COLUMN XVC105E 40X40X1	2	PZ																																															
TB3081A0	LMISS ARIANNA/ROS SELLA DOOR LEFT COLUMN	1	PZ																																															
VM1025A0	Ø16 GREY NYLON LID	2	PZ																																															
VM1695A0	HANDLE POSITION PIN	2	PZ																																															
VM1920A0	INTERNAL GLASS CLOSING RIGHT PLATE	1	PZ																																															
VM1921A0	INTERNAL GLASS CLOSING LEFT PLATE	1	PZ																																															
VM2062A0	L.MISS 46X33 RIGHT UPPER DOOR COLUMN CAP	1	PZ																																															
VM2063A0	L.MISS 46X33 LEFT UPPER DOOR COLUMN CAP	1	PZ																																															
VM2064A0	L.MISS 46X33 RIGHT LOWER DOOR COLUMN CAP	1	PZ																																															

COMPONENT			SPARE PART																																																																							
Code	Description	Image	Code	Description	Components list																																																																					
VM1920A	INTERNAL GLASS CLOSING RIGHT PLATE		KVT1252A	XF135-EG- VT1252A EXTERNAL GLASS KIT	<table border="1"> <thead> <tr> <th>Code</th> <th>Description</th> <th>Qty</th> <th>UOM</th> </tr> </thead> <tbody> <tr> <td>VM2065A0</td> <td>L.MISS 46X33 LEFT LOWER DOOR COLUMN CAP</td> <td>1</td> <td>PZ</td> </tr> <tr> <td>VT1252A0</td> <td>XFT135 DOOR EXT. BLACK GLASS - ENGEFOOD</td> <td>1</td> <td>PZ</td> </tr> </tbody> </table>	Code	Description	Qty	UOM	VM2065A0	L.MISS 46X33 LEFT LOWER DOOR COLUMN CAP	1	PZ	VT1252A0	XFT135 DOOR EXT. BLACK GLASS - ENGEFOOD	1	PZ																																																									
			Code	Description	Qty	UOM																																																																				
VM2065A0	L.MISS 46X33 LEFT LOWER DOOR COLUMN CAP	1	PZ																																																																							
VT1252A0	XFT135 DOOR EXT. BLACK GLASS - ENGEFOOD	1	PZ																																																																							
KVT1072A	L.M. ROSSELLA BLACK EXTERNAL GLASS KIT	<table border="1"> <thead> <tr> <th>Code</th> <th>Description</th> <th>Qty</th> <th>UOM</th> </tr> </thead> <tbody> <tr> <td>IP1385A1</td> <td>CORNER POLYSTYREN E PACKING 110X80X2000</td> <td>0.960</td> <td>M</td> </tr> <tr> <td>IP1508A0</td> <td></td> <td>1.280</td> <td>PZ</td> </tr> <tr> <td>IP1508A1</td> <td>POLYSTYREN E U SHAPED PROFILE 2000X60X60</td> <td>1.270</td> <td>M</td> </tr> <tr> <td>RC1200A0</td> <td>ED=4 WIRE D.=0.5 COMPRESSIO N SPRING</td> <td>2</td> <td>PZ</td> </tr> <tr> <td>SL1050A1</td> <td>3M TRANSFER ADHESIVE TAPE</td> <td>0.820</td> <td>M</td> </tr> <tr> <td>TB2301A0</td> <td>RIGHT COLUMN XVC105E 40X40X1</td> <td>2</td> <td>PZ</td> </tr> <tr> <td>TB3081A0</td> <td>LMISS ARIANNA/ROS SELLA DOOR LEFT COLUMN</td> <td>1</td> <td>PZ</td> </tr> <tr> <td>VM1025A0</td> <td>Ø16 GREY NYLON LID</td> <td>2</td> <td>PZ</td> </tr> <tr> <td>VM1059A1</td> <td>HEAT SHRINK FILM H800</td> <td>1.300</td> <td>M</td> </tr> <tr> <td>VM1695A0</td> <td>HANDLE POSITION PIN</td> <td>2</td> <td>PZ</td> </tr> <tr> <td>VM1916A0</td> <td>RIGHT UPPER COLUMN CAP</td> <td>1</td> <td>PZ</td> </tr> <tr> <td>VM1917A0</td> <td>LEFT UPPER COLUMN CAP</td> <td>1</td> <td>PZ</td> </tr> <tr> <td>VM1918A0</td> <td>RIGHT LOWER COLUMN CAP</td> <td>1</td> <td>PZ</td> </tr> <tr> <td>VM1919A0</td> <td>LEFT LOWER COLUMN CAP</td> <td>1</td> <td>PZ</td> </tr> <tr> <td>VM1920A0</td> <td>INTERNAL GLASS CLOSING RIGHT PLATE</td> <td>1</td> <td>PZ</td> </tr> <tr> <td>VM1921A0</td> <td>INTERNAL GLASS CLOSING LEFT PLATE</td> <td>1</td> <td>PZ</td> </tr> <tr> <td>VT1072A0</td> <td>LINEMISS ROSSELLA BLACK EXTERNAL GLASS</td> <td>1</td> <td>PZ</td> </tr> </tbody> </table>	Code	Description	Qty	UOM	IP1385A1	CORNER POLYSTYREN E PACKING 110X80X2000	0.960	M	IP1508A0		1.280	PZ	IP1508A1	POLYSTYREN E U SHAPED PROFILE 2000X60X60	1.270	M	RC1200A0	ED=4 WIRE D.=0.5 COMPRESSIO N SPRING	2	PZ	SL1050A1	3M TRANSFER ADHESIVE TAPE	0.820	M	TB2301A0	RIGHT COLUMN XVC105E 40X40X1	2	PZ	TB3081A0	LMISS ARIANNA/ROS SELLA DOOR LEFT COLUMN	1	PZ	VM1025A0	Ø16 GREY NYLON LID	2	PZ	VM1059A1	HEAT SHRINK FILM H800	1.300	M	VM1695A0	HANDLE POSITION PIN	2	PZ	VM1916A0	RIGHT UPPER COLUMN CAP	1	PZ	VM1917A0	LEFT UPPER COLUMN CAP	1	PZ	VM1918A0	RIGHT LOWER COLUMN CAP	1	PZ	VM1919A0	LEFT LOWER COLUMN CAP	1	PZ	VM1920A0	INTERNAL GLASS CLOSING RIGHT PLATE	1	PZ	VM1921A0	INTERNAL GLASS CLOSING LEFT PLATE	1	PZ	VT1072A0	LINEMISS ROSSELLA BLACK EXTERNAL GLASS	1	PZ
Code	Description	Qty	UOM																																																																							
IP1385A1	CORNER POLYSTYREN E PACKING 110X80X2000	0.960	M																																																																							
IP1508A0		1.280	PZ																																																																							
IP1508A1	POLYSTYREN E U SHAPED PROFILE 2000X60X60	1.270	M																																																																							
RC1200A0	ED=4 WIRE D.=0.5 COMPRESSIO N SPRING	2	PZ																																																																							
SL1050A1	3M TRANSFER ADHESIVE TAPE	0.820	M																																																																							
TB2301A0	RIGHT COLUMN XVC105E 40X40X1	2	PZ																																																																							
TB3081A0	LMISS ARIANNA/ROS SELLA DOOR LEFT COLUMN	1	PZ																																																																							
VM1025A0	Ø16 GREY NYLON LID	2	PZ																																																																							
VM1059A1	HEAT SHRINK FILM H800	1.300	M																																																																							
VM1695A0	HANDLE POSITION PIN	2	PZ																																																																							
VM1916A0	RIGHT UPPER COLUMN CAP	1	PZ																																																																							
VM1917A0	LEFT UPPER COLUMN CAP	1	PZ																																																																							
VM1918A0	RIGHT LOWER COLUMN CAP	1	PZ																																																																							
VM1919A0	LEFT LOWER COLUMN CAP	1	PZ																																																																							
VM1920A0	INTERNAL GLASS CLOSING RIGHT PLATE	1	PZ																																																																							
VM1921A0	INTERNAL GLASS CLOSING LEFT PLATE	1	PZ																																																																							
VT1072A0	LINEMISS ROSSELLA BLACK EXTERNAL GLASS	1	PZ																																																																							

COMPONENT			SPARE PART																																																																																					
Code	Description	Image	Code	Description	Components list																																																																																			
VM1920A	INTERNAL GLASS CLOSING RIGHT PLATE		KVT1071A	L.M. ROSSELLA EXTERNAL GLASS KIT	<table border="1"> <thead> <tr> <th>Code</th> <th>Description</th> <th>Qty</th> <th>UOM</th> </tr> </thead> <tbody> <tr> <td>IP1385A1</td> <td>CORNER POLYSTYREN E PACKING 110X80X2000</td> <td>0.960</td> <td>M</td> </tr> <tr> <td>IP1508A0</td> <td></td> <td>1.300</td> <td>PZ</td> </tr> <tr> <td>IP1508A1</td> <td>POLYSTYREN E U SHAPED PROFILE 2000X60X60</td> <td>2</td> <td>M</td> </tr> <tr> <td>RC1200A0</td> <td>ED=4 WIRE D.=0.5 COMPRESSIO N SPRING</td> <td>2</td> <td>PZ</td> </tr> <tr> <td>SL1050A1</td> <td>3M TRANSFER ADHESIVE TAPE</td> <td>0.820</td> <td>M</td> </tr> <tr> <td>TB2301A0</td> <td>RIGHT COLUMN XVC105E 40X40X1</td> <td>2</td> <td>PZ</td> </tr> <tr> <td>VM1025A0</td> <td>Ø16 GREY NYLON LID</td> <td>2</td> <td>PZ</td> </tr> <tr> <td>VM1059A1</td> <td>HEAT SHRINK FILM H800</td> <td>1.350</td> <td>M</td> </tr> <tr> <td>VM1695A0</td> <td>HANDLE POSITION PIN</td> <td>2</td> <td>PZ</td> </tr> <tr> <td>VM1916A0</td> <td>RIGHT UPPER COLUMN CAP</td> <td>1</td> <td>PZ</td> </tr> <tr> <td>VM1917A0</td> <td>LEFT UPPER COLUMN CAP</td> <td>1</td> <td>PZ</td> </tr> <tr> <td>VM1918A0</td> <td>RIGHT LOWER COLUMN CAP</td> <td>1</td> <td>PZ</td> </tr> <tr> <td>VM1919A0</td> <td>LEFT LOWER COLUMN CAP</td> <td>1</td> <td>PZ</td> </tr> <tr> <td>VM1920A0</td> <td>INTERNAL GLASS CLOSING RIGHT PLATE</td> <td>1</td> <td>PZ</td> </tr> <tr> <td>VM1921A0</td> <td>INTERNAL GLASS CLOSING LEFT PLATE</td> <td>1</td> <td>PZ</td> </tr> <tr> <td>VT1071A2</td> <td>YELLOW SER GLASS 798X424X5</td> <td>1</td> <td>PZ</td> </tr> </tbody> </table>	Code	Description	Qty	UOM	IP1385A1	CORNER POLYSTYREN E PACKING 110X80X2000	0.960	M	IP1508A0		1.300	PZ	IP1508A1	POLYSTYREN E U SHAPED PROFILE 2000X60X60	2	M	RC1200A0	ED=4 WIRE D.=0.5 COMPRESSIO N SPRING	2	PZ	SL1050A1	3M TRANSFER ADHESIVE TAPE	0.820	M	TB2301A0	RIGHT COLUMN XVC105E 40X40X1	2	PZ	VM1025A0	Ø16 GREY NYLON LID	2	PZ	VM1059A1	HEAT SHRINK FILM H800	1.350	M	VM1695A0	HANDLE POSITION PIN	2	PZ	VM1916A0	RIGHT UPPER COLUMN CAP	1	PZ	VM1917A0	LEFT UPPER COLUMN CAP	1	PZ	VM1918A0	RIGHT LOWER COLUMN CAP	1	PZ	VM1919A0	LEFT LOWER COLUMN CAP	1	PZ	VM1920A0	INTERNAL GLASS CLOSING RIGHT PLATE	1	PZ	VM1921A0	INTERNAL GLASS CLOSING LEFT PLATE	1	PZ	VT1071A2	YELLOW SER GLASS 798X424X5	1	PZ	KVT1067A	L.M. ELENA BLACK EXTERNAL GLASS KIT	<table border="1"> <thead> <tr> <th>Code</th> <th>Description</th> <th>Qty</th> <th>UOM</th> </tr> </thead> <tbody> <tr> <td>IP1385A1</td> <td>CORNER POLYSTYREN E PACKING 110X80X2000</td> <td>0.800</td> <td>M</td> </tr> <tr> <td>IP1508A0</td> <td></td> <td>1.710</td> <td>PZ</td> </tr> </tbody> </table>	Code	Description	Qty	UOM	IP1385A1	CORNER POLYSTYREN E PACKING 110X80X2000	0.800	M	IP1508A0		1.710	PZ
			Code	Description	Qty	UOM																																																																																		
IP1385A1	CORNER POLYSTYREN E PACKING 110X80X2000	0.960	M																																																																																					
IP1508A0		1.300	PZ																																																																																					
IP1508A1	POLYSTYREN E U SHAPED PROFILE 2000X60X60	2	M																																																																																					
RC1200A0	ED=4 WIRE D.=0.5 COMPRESSIO N SPRING	2	PZ																																																																																					
SL1050A1	3M TRANSFER ADHESIVE TAPE	0.820	M																																																																																					
TB2301A0	RIGHT COLUMN XVC105E 40X40X1	2	PZ																																																																																					
VM1025A0	Ø16 GREY NYLON LID	2	PZ																																																																																					
VM1059A1	HEAT SHRINK FILM H800	1.350	M																																																																																					
VM1695A0	HANDLE POSITION PIN	2	PZ																																																																																					
VM1916A0	RIGHT UPPER COLUMN CAP	1	PZ																																																																																					
VM1917A0	LEFT UPPER COLUMN CAP	1	PZ																																																																																					
VM1918A0	RIGHT LOWER COLUMN CAP	1	PZ																																																																																					
VM1919A0	LEFT LOWER COLUMN CAP	1	PZ																																																																																					
VM1920A0	INTERNAL GLASS CLOSING RIGHT PLATE	1	PZ																																																																																					
VM1921A0	INTERNAL GLASS CLOSING LEFT PLATE	1	PZ																																																																																					
VT1071A2	YELLOW SER GLASS 798X424X5	1	PZ																																																																																					
Code	Description	Qty	UOM																																																																																					
IP1385A1	CORNER POLYSTYREN E PACKING 110X80X2000	0.800	M																																																																																					
IP1508A0		1.710	PZ																																																																																					

COMPONENT			SPARE PART																																																																																	
Code	Description	Image	Code	Description	Components list																																																																															
VM1920A	INTERNAL GLASS CLOSING RIGHT PLATE		KVT1067A	L.M. ELENA BLACK EXTERNAL GLASS KIT	<table border="1"> <thead> <tr> <th>Code</th> <th>Description</th> <th>Qty</th> <th>UOM</th> </tr> </thead> <tbody> <tr> <td>IP1508A1</td> <td>POLYSTYREN E U SHAPED PROFILE 2000X60X60</td> <td>2</td> <td>M</td> </tr> <tr> <td>RC1200A0</td> <td>ED=4 WIRE COMPRESSIO N SPRING</td> <td>2</td> <td>PZ</td> </tr> <tr> <td>SL1050A1</td> <td>3M TRANSFER ADHESIVE TAPE</td> <td>0.660</td> <td>M</td> </tr> <tr> <td>TB2306A0</td> <td>LMISS STEFANIA/ELE NA DOOR RIGHT COLUM</td> <td>2</td> <td>PZ</td> </tr> <tr> <td>TB3080A0</td> <td>LMISS STEFANIA/ELE NA DOOR LEFT COLUMN</td> <td>1</td> <td>PZ</td> </tr> <tr> <td>VM1025A0</td> <td>Ø16 GREY NYLON LID</td> <td>2</td> <td>PZ</td> </tr> <tr> <td>VM1059A1</td> <td>HEAT SHRINK FILM H800</td> <td>1.350</td> <td>M</td> </tr> <tr> <td>VM1695A0</td> <td>HANDLE POSITION PIN</td> <td>2</td> <td>PZ</td> </tr> <tr> <td>VM1916A0</td> <td>RIGHT UPPER COLUMN CAP</td> <td>1</td> <td>PZ</td> </tr> <tr> <td>VM1917A0</td> <td>LEFT UPPER COLUMN CAP</td> <td>1</td> <td>PZ</td> </tr> <tr> <td>VM1918A0</td> <td>RIGHT LOWER COLUMN CAP</td> <td>1</td> <td>PZ</td> </tr> <tr> <td>VM1919A0</td> <td>LEFT LOWER COLUMN CAP</td> <td>1</td> <td>PZ</td> </tr> <tr> <td>VM1920A0</td> <td>INTERNAL GLASS CLOSING RIGHT PLATE</td> <td>1</td> <td>PZ</td> </tr> <tr> <td>VM1921A0</td> <td>INTERNAL GLASS CLOSING LEFT PLATE</td> <td>1</td> <td>PZ</td> </tr> <tr> <td>VT1067A0</td> <td>LINEMISS ELENA BLACK EXTERNAL DOOR GLASS</td> <td>1</td> <td>PZ</td> </tr> </tbody> </table>	Code	Description	Qty	UOM	IP1508A1	POLYSTYREN E U SHAPED PROFILE 2000X60X60	2	M	RC1200A0	ED=4 WIRE COMPRESSIO N SPRING	2	PZ	SL1050A1	3M TRANSFER ADHESIVE TAPE	0.660	M	TB2306A0	LMISS STEFANIA/ELE NA DOOR RIGHT COLUM	2	PZ	TB3080A0	LMISS STEFANIA/ELE NA DOOR LEFT COLUMN	1	PZ	VM1025A0	Ø16 GREY NYLON LID	2	PZ	VM1059A1	HEAT SHRINK FILM H800	1.350	M	VM1695A0	HANDLE POSITION PIN	2	PZ	VM1916A0	RIGHT UPPER COLUMN CAP	1	PZ	VM1917A0	LEFT UPPER COLUMN CAP	1	PZ	VM1918A0	RIGHT LOWER COLUMN CAP	1	PZ	VM1919A0	LEFT LOWER COLUMN CAP	1	PZ	VM1920A0	INTERNAL GLASS CLOSING RIGHT PLATE	1	PZ	VM1921A0	INTERNAL GLASS CLOSING LEFT PLATE	1	PZ	VT1067A0	LINEMISS ELENA BLACK EXTERNAL DOOR GLASS	1	PZ	KVT1066A	L.M. ELENA EXTERNAL GLASS KIT	<table border="1"> <thead> <tr> <th>Code</th> <th>Description</th> <th>Qty</th> <th>UOM</th> </tr> </thead> <tbody> <tr> <td>IP1385A1</td> <td>CORNER POLYSTYREN E PACKING 110X80X2000</td> <td>0.800</td> <td>M</td> </tr> <tr> <td>IP1508A0</td> <td></td> <td>1.710</td> <td>PZ</td> </tr> </tbody> </table>	Code	Description	Qty	UOM	IP1385A1	CORNER POLYSTYREN E PACKING 110X80X2000	0.800	M	IP1508A0		1.710	PZ
			Code	Description	Qty	UOM																																																																														
IP1508A1	POLYSTYREN E U SHAPED PROFILE 2000X60X60	2	M																																																																																	
RC1200A0	ED=4 WIRE COMPRESSIO N SPRING	2	PZ																																																																																	
SL1050A1	3M TRANSFER ADHESIVE TAPE	0.660	M																																																																																	
TB2306A0	LMISS STEFANIA/ELE NA DOOR RIGHT COLUM	2	PZ																																																																																	
TB3080A0	LMISS STEFANIA/ELE NA DOOR LEFT COLUMN	1	PZ																																																																																	
VM1025A0	Ø16 GREY NYLON LID	2	PZ																																																																																	
VM1059A1	HEAT SHRINK FILM H800	1.350	M																																																																																	
VM1695A0	HANDLE POSITION PIN	2	PZ																																																																																	
VM1916A0	RIGHT UPPER COLUMN CAP	1	PZ																																																																																	
VM1917A0	LEFT UPPER COLUMN CAP	1	PZ																																																																																	
VM1918A0	RIGHT LOWER COLUMN CAP	1	PZ																																																																																	
VM1919A0	LEFT LOWER COLUMN CAP	1	PZ																																																																																	
VM1920A0	INTERNAL GLASS CLOSING RIGHT PLATE	1	PZ																																																																																	
VM1921A0	INTERNAL GLASS CLOSING LEFT PLATE	1	PZ																																																																																	
VT1067A0	LINEMISS ELENA BLACK EXTERNAL DOOR GLASS	1	PZ																																																																																	
Code	Description	Qty	UOM																																																																																	
IP1385A1	CORNER POLYSTYREN E PACKING 110X80X2000	0.800	M																																																																																	
IP1508A0		1.710	PZ																																																																																	

COMPONENT			SPARE PART																																																																																					
Code	Description	Image	Code	Description	Components list																																																																																			
VM1920A	INTERNAL GLASS CLOSING RIGHT PLATE		KVT1066A	L.M. ELENA EXTERNAL GLASS KIT	<table border="1"> <thead> <tr> <th>Code</th> <th>Description</th> <th>Qty</th> <th>UOM</th> </tr> </thead> <tbody> <tr> <td>IP1508A1</td> <td>POLYSTYREN E U SHAPED PROFILE 2000X60X60</td> <td>2</td> <td>M</td> </tr> <tr> <td>RC1200A0</td> <td>ED=4 WIRE D.=0.5 COMPRESSIO N SPRING</td> <td>2</td> <td>PZ</td> </tr> <tr> <td>SL1050A1</td> <td>3M TRANSFER ADHESIVE TAPE</td> <td>0.660</td> <td>M</td> </tr> <tr> <td>TB2306A0</td> <td>LMISS STEFANIA/ELE NA DOOR RIGHT COLUM</td> <td>2</td> <td>PZ</td> </tr> <tr> <td>VM1025A0</td> <td>Ø16 GREY NYLON LID</td> <td>2</td> <td>PZ</td> </tr> <tr> <td>VM1059A1</td> <td>HEAT SHRINK FILM H800</td> <td>1.350</td> <td>M</td> </tr> <tr> <td>VM1695A0</td> <td>HANDLE POSITION PIN</td> <td>2</td> <td>PZ</td> </tr> <tr> <td>VM1916A0</td> <td>RIGHT UPPER COLUMN CAP</td> <td>1</td> <td>PZ</td> </tr> <tr> <td>VM1917A0</td> <td>LEFT UPPER COLUMN CAP</td> <td>1</td> <td>PZ</td> </tr> <tr> <td>VM1918A0</td> <td>RIGHT LOWER COLUMN CAP</td> <td>1</td> <td>PZ</td> </tr> <tr> <td>VM1919A0</td> <td>LEFT LOWER COLUMN CAP</td> <td>1</td> <td>PZ</td> </tr> <tr> <td>VM1920A0</td> <td>INTERNAL GLASS CLOSING RIGHT PLATE</td> <td>1</td> <td>PZ</td> </tr> <tr> <td>VM1921A0</td> <td>INTERNAL GLASS CLOSING LEFT PLATE</td> <td>1</td> <td>PZ</td> </tr> <tr> <td>VT1066A2</td> <td>YELLOW SER GLASS 798X344X5</td> <td>1</td> <td>PZ</td> </tr> </tbody> </table>	Code	Description	Qty	UOM	IP1508A1	POLYSTYREN E U SHAPED PROFILE 2000X60X60	2	M	RC1200A0	ED=4 WIRE D.=0.5 COMPRESSIO N SPRING	2	PZ	SL1050A1	3M TRANSFER ADHESIVE TAPE	0.660	M	TB2306A0	LMISS STEFANIA/ELE NA DOOR RIGHT COLUM	2	PZ	VM1025A0	Ø16 GREY NYLON LID	2	PZ	VM1059A1	HEAT SHRINK FILM H800	1.350	M	VM1695A0	HANDLE POSITION PIN	2	PZ	VM1916A0	RIGHT UPPER COLUMN CAP	1	PZ	VM1917A0	LEFT UPPER COLUMN CAP	1	PZ	VM1918A0	RIGHT LOWER COLUMN CAP	1	PZ	VM1919A0	LEFT LOWER COLUMN CAP	1	PZ	VM1920A0	INTERNAL GLASS CLOSING RIGHT PLATE	1	PZ	VM1921A0	INTERNAL GLASS CLOSING LEFT PLATE	1	PZ	VT1066A2	YELLOW SER GLASS 798X344X5	1	PZ	KVT1063A	L.MISS ARIANNA FORNETTI EXT. GLASS KIT	<table border="1"> <thead> <tr> <th>Code</th> <th>Description</th> <th>Qty</th> <th>UOM</th> </tr> </thead> <tbody> <tr> <td>IP1385A1</td> <td>CORNER POLYSTYREN E PACKING 110X80X2000</td> <td>0.980</td> <td>M</td> </tr> <tr> <td>IP1508A0</td> <td></td> <td>0.960</td> <td>PZ</td> </tr> <tr> <td>IP1508A1</td> <td>POLYSTYREN E U SHAPED PROFILE 2000X60X60</td> <td>0.960</td> <td>M</td> </tr> <tr> <td>MS1009A0</td> <td>FORNETTI LOGO LABEL</td> <td>1</td> <td>PZ</td> </tr> </tbody> </table>	Code	Description	Qty	UOM	IP1385A1	CORNER POLYSTYREN E PACKING 110X80X2000	0.980	M	IP1508A0		0.960	PZ	IP1508A1	POLYSTYREN E U SHAPED PROFILE 2000X60X60	0.960	M	MS1009A0	FORNETTI LOGO LABEL	1	PZ
			Code	Description	Qty	UOM																																																																																		
IP1508A1	POLYSTYREN E U SHAPED PROFILE 2000X60X60	2	M																																																																																					
RC1200A0	ED=4 WIRE D.=0.5 COMPRESSIO N SPRING	2	PZ																																																																																					
SL1050A1	3M TRANSFER ADHESIVE TAPE	0.660	M																																																																																					
TB2306A0	LMISS STEFANIA/ELE NA DOOR RIGHT COLUM	2	PZ																																																																																					
VM1025A0	Ø16 GREY NYLON LID	2	PZ																																																																																					
VM1059A1	HEAT SHRINK FILM H800	1.350	M																																																																																					
VM1695A0	HANDLE POSITION PIN	2	PZ																																																																																					
VM1916A0	RIGHT UPPER COLUMN CAP	1	PZ																																																																																					
VM1917A0	LEFT UPPER COLUMN CAP	1	PZ																																																																																					
VM1918A0	RIGHT LOWER COLUMN CAP	1	PZ																																																																																					
VM1919A0	LEFT LOWER COLUMN CAP	1	PZ																																																																																					
VM1920A0	INTERNAL GLASS CLOSING RIGHT PLATE	1	PZ																																																																																					
VM1921A0	INTERNAL GLASS CLOSING LEFT PLATE	1	PZ																																																																																					
VT1066A2	YELLOW SER GLASS 798X344X5	1	PZ																																																																																					
Code	Description	Qty	UOM																																																																																					
IP1385A1	CORNER POLYSTYREN E PACKING 110X80X2000	0.980	M																																																																																					
IP1508A0		0.960	PZ																																																																																					
IP1508A1	POLYSTYREN E U SHAPED PROFILE 2000X60X60	0.960	M																																																																																					
MS1009A0	FORNETTI LOGO LABEL	1	PZ																																																																																					

COMPONENT			SPARE PART																																																																									
Code	Description	Image	Code	Description	Components list																																																																							
VM1920A	INTERNAL GLASS CLOSING RIGHT PLATE		KVT1063A	L.MISS ARIANNA FORNETTI EXT. GLASS KIT	<table border="1"> <thead> <tr> <th>Code</th> <th>Description</th> <th>Qty</th> <th>UOM</th> </tr> </thead> <tbody> <tr> <td>RC1200A0</td> <td>ED=4 WIRE D.=0.5 COMPRESSIO N SPRING</td> <td>2</td> <td>PZ</td> </tr> <tr> <td>SL1050A1</td> <td>3M TRANSFER ADHESIVE TAPE</td> <td>0.820</td> <td>M</td> </tr> <tr> <td>TB2301A0</td> <td>RIGHT COLUMN XVC105E 40X40X1</td> <td>2</td> <td>PZ</td> </tr> <tr> <td>TB3081A0</td> <td>LMISS ARIANNA/ROS SELLA DOOR LEFT COLUMN</td> <td>1</td> <td>PZ</td> </tr> <tr> <td>VM1025A0</td> <td>Ø16 GREY NYLON LID</td> <td>2</td> <td>PZ</td> </tr> <tr> <td>VM1059A1</td> <td>HEAT SHRINK FILM H800</td> <td>1.300</td> <td>M</td> </tr> <tr> <td>VM1695A0</td> <td>HANDLE POSITION PIN</td> <td>2</td> <td>PZ</td> </tr> <tr> <td>VM1920A0</td> <td>INTERNAL GLASS CLOSING RIGHT PLATE</td> <td>1</td> <td>PZ</td> </tr> <tr> <td>VM1921A0</td> <td>INTERNAL GLASS CLOSING LEFT PLATE</td> <td>1</td> <td>PZ</td> </tr> <tr> <td>VM2062A0</td> <td>L.MISS 46X33 RIGHT UPPER DOOR COLUMN CAP</td> <td>1</td> <td>PZ</td> </tr> <tr> <td>VM2063A0</td> <td>L.MISS 46X33 LEFT UPPER DOOR COLUMN CAP</td> <td>1</td> <td>PZ</td> </tr> <tr> <td>VM2064A0</td> <td>L.MISS 46X33 RIGHT LOWER DOOR COLUMN CAP</td> <td>1</td> <td>PZ</td> </tr> <tr> <td>VM2065A0</td> <td>L.MISS 46X33 LEFT LOWER DOOR COLUMN CAP</td> <td>1</td> <td>PZ</td> </tr> <tr> <td>VT1063A0</td> <td>XF135F EXTERNAL GLASS 598X42</td> <td>1</td> <td>PZ</td> </tr> </tbody> </table>	Code	Description	Qty	UOM	RC1200A0	ED=4 WIRE D.=0.5 COMPRESSIO N SPRING	2	PZ	SL1050A1	3M TRANSFER ADHESIVE TAPE	0.820	M	TB2301A0	RIGHT COLUMN XVC105E 40X40X1	2	PZ	TB3081A0	LMISS ARIANNA/ROS SELLA DOOR LEFT COLUMN	1	PZ	VM1025A0	Ø16 GREY NYLON LID	2	PZ	VM1059A1	HEAT SHRINK FILM H800	1.300	M	VM1695A0	HANDLE POSITION PIN	2	PZ	VM1920A0	INTERNAL GLASS CLOSING RIGHT PLATE	1	PZ	VM1921A0	INTERNAL GLASS CLOSING LEFT PLATE	1	PZ	VM2062A0	L.MISS 46X33 RIGHT UPPER DOOR COLUMN CAP	1	PZ	VM2063A0	L.MISS 46X33 LEFT UPPER DOOR COLUMN CAP	1	PZ	VM2064A0	L.MISS 46X33 RIGHT LOWER DOOR COLUMN CAP	1	PZ	VM2065A0	L.MISS 46X33 LEFT LOWER DOOR COLUMN CAP	1	PZ	VT1063A0	XF135F EXTERNAL GLASS 598X42	1	PZ	KVT1062A	L.M. ARIANNA BLACK EXTERNAL GLASS KIT	<table border="1"> <thead> <tr> <th>Code</th> <th>Description</th> <th>Qty</th> <th>UOM</th> </tr> </thead> <tbody> <tr> <td>IP1385A1</td> <td>CORNER POLYSTYREN E PACKING 110X80X2000</td> <td>1.280</td> <td>M</td> </tr> </tbody> </table>	Code	Description	Qty	UOM	IP1385A1	CORNER POLYSTYREN E PACKING 110X80X2000	1.280	M
			Code	Description	Qty	UOM																																																																						
RC1200A0	ED=4 WIRE D.=0.5 COMPRESSIO N SPRING	2	PZ																																																																									
SL1050A1	3M TRANSFER ADHESIVE TAPE	0.820	M																																																																									
TB2301A0	RIGHT COLUMN XVC105E 40X40X1	2	PZ																																																																									
TB3081A0	LMISS ARIANNA/ROS SELLA DOOR LEFT COLUMN	1	PZ																																																																									
VM1025A0	Ø16 GREY NYLON LID	2	PZ																																																																									
VM1059A1	HEAT SHRINK FILM H800	1.300	M																																																																									
VM1695A0	HANDLE POSITION PIN	2	PZ																																																																									
VM1920A0	INTERNAL GLASS CLOSING RIGHT PLATE	1	PZ																																																																									
VM1921A0	INTERNAL GLASS CLOSING LEFT PLATE	1	PZ																																																																									
VM2062A0	L.MISS 46X33 RIGHT UPPER DOOR COLUMN CAP	1	PZ																																																																									
VM2063A0	L.MISS 46X33 LEFT UPPER DOOR COLUMN CAP	1	PZ																																																																									
VM2064A0	L.MISS 46X33 RIGHT LOWER DOOR COLUMN CAP	1	PZ																																																																									
VM2065A0	L.MISS 46X33 LEFT LOWER DOOR COLUMN CAP	1	PZ																																																																									
VT1063A0	XF135F EXTERNAL GLASS 598X42	1	PZ																																																																									
Code	Description	Qty	UOM																																																																									
IP1385A1	CORNER POLYSTYREN E PACKING 110X80X2000	1.280	M																																																																									





COMPONENT			SPARE PART																																																														
Code	Description	Image	Code	Description	Components list																																																												
VM1920A	INTERNAL GLASS CLOSING RIGHT PLATE		KVT1062A	L.M. ARIANNA BLACK EXTERNAL GLASS KIT	<table border="1"> <thead> <tr> <th>Code</th> <th>Description</th> <th>Qty</th> <th>UOM</th> </tr> </thead> <tbody> <tr> <td>RC1200A0</td> <td>ED=4 WIRE D.=0.5 COMPRESSIO N SPRING</td> <td>2</td> <td>PZ</td> </tr> <tr> <td>SL1050A1</td> <td>3M TRANSFER ADHESIVE TAPE</td> <td>0.820</td> <td>M</td> </tr> <tr> <td>TB2301A0</td> <td>RIGHT COLUMN XVC105E 40X40X1</td> <td>2</td> <td>PZ</td> </tr> <tr> <td>TB3081A0</td> <td>LMISS ARIANNA/ROS SELLA DOOR LEFT COLUMN</td> <td>1</td> <td>PZ</td> </tr> <tr> <td>VM1025A0</td> <td>Ø16 GREY NYLON LID</td> <td>2</td> <td>PZ</td> </tr> <tr> <td>VM1059A1</td> <td>HEAT SHRINK FILM H800</td> <td>1</td> <td>M</td> </tr> <tr> <td>VM1695A0</td> <td>HANDLE POSITION PIN</td> <td>2</td> <td>PZ</td> </tr> <tr> <td>VM1920A0</td> <td>INTERNAL GLASS CLOSING RIGHT PLATE</td> <td>1</td> <td>PZ</td> </tr> <tr> <td>VM1921A0</td> <td>INTERNAL GLASS CLOSING LEFT PLATE</td> <td>1</td> <td>PZ</td> </tr> <tr> <td>VM2062A0</td> <td>L.MISS 46X33 RIGHT UPPER DOOR COLUMN CAP</td> <td>1</td> <td>PZ</td> </tr> <tr> <td>VM2063A0</td> <td>L.MISS 46X33 LEFT UPPER DOOR COLUMN CAP</td> <td>1</td> <td>PZ</td> </tr> <tr> <td>VM2064A0</td> <td>L.MISS 46X33 RIGHT LOWER DOOR COLUMN CAP</td> <td>1</td> <td>PZ</td> </tr> <tr> <td>VM2065A0</td> <td>L.MISS 46X33 LEFT LOWER DOOR COLUMN CAP</td> <td>1</td> <td>PZ</td> </tr> <tr> <td>VT1062A0</td> <td>LINEMISS ARIANNA GREY EXTERNAL GLASS</td> <td>1</td> <td>PZ</td> </tr> </tbody> </table>	Code	Description	Qty	UOM	RC1200A0	ED=4 WIRE D.=0.5 COMPRESSIO N SPRING	2	PZ	SL1050A1	3M TRANSFER ADHESIVE TAPE	0.820	M	TB2301A0	RIGHT COLUMN XVC105E 40X40X1	2	PZ	TB3081A0	LMISS ARIANNA/ROS SELLA DOOR LEFT COLUMN	1	PZ	VM1025A0	Ø16 GREY NYLON LID	2	PZ	VM1059A1	HEAT SHRINK FILM H800	1	M	VM1695A0	HANDLE POSITION PIN	2	PZ	VM1920A0	INTERNAL GLASS CLOSING RIGHT PLATE	1	PZ	VM1921A0	INTERNAL GLASS CLOSING LEFT PLATE	1	PZ	VM2062A0	L.MISS 46X33 RIGHT UPPER DOOR COLUMN CAP	1	PZ	VM2063A0	L.MISS 46X33 LEFT UPPER DOOR COLUMN CAP	1	PZ	VM2064A0	L.MISS 46X33 RIGHT LOWER DOOR COLUMN CAP	1	PZ	VM2065A0	L.MISS 46X33 LEFT LOWER DOOR COLUMN CAP	1	PZ	VT1062A0	LINEMISS ARIANNA GREY EXTERNAL GLASS	1	PZ
Code	Description	Qty	UOM																																																														
RC1200A0	ED=4 WIRE D.=0.5 COMPRESSIO N SPRING	2	PZ																																																														
SL1050A1	3M TRANSFER ADHESIVE TAPE	0.820	M																																																														
TB2301A0	RIGHT COLUMN XVC105E 40X40X1	2	PZ																																																														
TB3081A0	LMISS ARIANNA/ROS SELLA DOOR LEFT COLUMN	1	PZ																																																														
VM1025A0	Ø16 GREY NYLON LID	2	PZ																																																														
VM1059A1	HEAT SHRINK FILM H800	1	M																																																														
VM1695A0	HANDLE POSITION PIN	2	PZ																																																														
VM1920A0	INTERNAL GLASS CLOSING RIGHT PLATE	1	PZ																																																														
VM1921A0	INTERNAL GLASS CLOSING LEFT PLATE	1	PZ																																																														
VM2062A0	L.MISS 46X33 RIGHT UPPER DOOR COLUMN CAP	1	PZ																																																														
VM2063A0	L.MISS 46X33 LEFT UPPER DOOR COLUMN CAP	1	PZ																																																														
VM2064A0	L.MISS 46X33 RIGHT LOWER DOOR COLUMN CAP	1	PZ																																																														
VM2065A0	L.MISS 46X33 LEFT LOWER DOOR COLUMN CAP	1	PZ																																																														
VT1062A0	LINEMISS ARIANNA GREY EXTERNAL GLASS	1	PZ																																																														

COMPONENT			SPARE PART																																																																									
Code	Description	Image	Code	Description	Components list																																																																							
VM1920A	INTERNAL GLASS CLOSING RIGHT PLATE		KVT1061A	L.M. ARIANNA EXTERNAL YELLOW GLASS KIT	<table border="1"> <thead> <tr> <th>Code</th> <th>Description</th> <th>Qty</th> <th>UOM</th> </tr> </thead> <tbody> <tr> <td>IP1385A1</td> <td>CORNER POLYSTYREN E PACKING 110X80X2000</td> <td>1.280</td> <td>M</td> </tr> <tr> <td>RC1200A0</td> <td>ED=4 WIRE D.=0.5 COMPRESSIO N SPRING</td> <td>2</td> <td>PZ</td> </tr> <tr> <td>SL1050A1</td> <td>3M TRANSFER ADHESIVE TAPE</td> <td>0.820</td> <td>M</td> </tr> <tr> <td>TB2301A0</td> <td>RIGHT COLUMN XVC105E 40X40X1</td> <td>2</td> <td>PZ</td> </tr> <tr> <td>VM1025A0</td> <td>Ø16 GREY NYLON LID</td> <td>2</td> <td>PZ</td> </tr> <tr> <td>VM1059A1</td> <td>HEAT SHRINK FILM H800</td> <td>1.300</td> <td>M</td> </tr> <tr> <td>VM1695A0</td> <td>HANDLE POSITION PIN</td> <td>2</td> <td>PZ</td> </tr> <tr> <td>VM1920A0</td> <td>INTERNAL GLASS CLOSING RIGHT PLATE</td> <td>1</td> <td>PZ</td> </tr> <tr> <td>VM1921A0</td> <td>INTERNAL GLASS CLOSING LEFT PLATE</td> <td>1</td> <td>PZ</td> </tr> <tr> <td>VM2062A0</td> <td>L.MISS 46X33 RIGHT UPPER DOOR COLUMN CAP</td> <td>1</td> <td>PZ</td> </tr> <tr> <td>VM2063A0</td> <td>L.MISS 46X33 LEFT UPPER DOOR COLUMN CAP</td> <td>1</td> <td>PZ</td> </tr> <tr> <td>VM2064A0</td> <td>L.MISS 46X33 RIGHT LOWER DOOR COLUMN CAP</td> <td>1</td> <td>PZ</td> </tr> <tr> <td>VM2065A0</td> <td>L.MISS 46X33 LEFT LOWER DOOR COLUMN CAP</td> <td>1</td> <td>PZ</td> </tr> <tr> <td>VT1061A2</td> <td>EXTERNAL YELLOW SER.GLASS 598X424X5</td> <td>1</td> <td>PZ</td> </tr> </tbody> </table>	Code	Description	Qty	UOM	IP1385A1	CORNER POLYSTYREN E PACKING 110X80X2000	1.280	M	RC1200A0	ED=4 WIRE D.=0.5 COMPRESSIO N SPRING	2	PZ	SL1050A1	3M TRANSFER ADHESIVE TAPE	0.820	M	TB2301A0	RIGHT COLUMN XVC105E 40X40X1	2	PZ	VM1025A0	Ø16 GREY NYLON LID	2	PZ	VM1059A1	HEAT SHRINK FILM H800	1.300	M	VM1695A0	HANDLE POSITION PIN	2	PZ	VM1920A0	INTERNAL GLASS CLOSING RIGHT PLATE	1	PZ	VM1921A0	INTERNAL GLASS CLOSING LEFT PLATE	1	PZ	VM2062A0	L.MISS 46X33 RIGHT UPPER DOOR COLUMN CAP	1	PZ	VM2063A0	L.MISS 46X33 LEFT UPPER DOOR COLUMN CAP	1	PZ	VM2064A0	L.MISS 46X33 RIGHT LOWER DOOR COLUMN CAP	1	PZ	VM2065A0	L.MISS 46X33 LEFT LOWER DOOR COLUMN CAP	1	PZ	VT1061A2	EXTERNAL YELLOW SER.GLASS 598X424X5	1	PZ	KVT1057A	LM STEFANIA BLACK EXTERNAL GLASS KIT	<table border="1"> <thead> <tr> <th>Code</th> <th>Description</th> <th>Qty</th> <th>UOM</th> </tr> </thead> <tbody> <tr> <td>IP1385A1</td> <td>CORNER POLYSTYREN E PACKING 110X80X2000</td> <td>0.810</td> <td>M</td> </tr> </tbody> </table>	Code	Description	Qty	UOM	IP1385A1	CORNER POLYSTYREN E PACKING 110X80X2000	0.810	M
			Code	Description	Qty	UOM																																																																						
IP1385A1	CORNER POLYSTYREN E PACKING 110X80X2000	1.280	M																																																																									
RC1200A0	ED=4 WIRE D.=0.5 COMPRESSIO N SPRING	2	PZ																																																																									
SL1050A1	3M TRANSFER ADHESIVE TAPE	0.820	M																																																																									
TB2301A0	RIGHT COLUMN XVC105E 40X40X1	2	PZ																																																																									
VM1025A0	Ø16 GREY NYLON LID	2	PZ																																																																									
VM1059A1	HEAT SHRINK FILM H800	1.300	M																																																																									
VM1695A0	HANDLE POSITION PIN	2	PZ																																																																									
VM1920A0	INTERNAL GLASS CLOSING RIGHT PLATE	1	PZ																																																																									
VM1921A0	INTERNAL GLASS CLOSING LEFT PLATE	1	PZ																																																																									
VM2062A0	L.MISS 46X33 RIGHT UPPER DOOR COLUMN CAP	1	PZ																																																																									
VM2063A0	L.MISS 46X33 LEFT UPPER DOOR COLUMN CAP	1	PZ																																																																									
VM2064A0	L.MISS 46X33 RIGHT LOWER DOOR COLUMN CAP	1	PZ																																																																									
VM2065A0	L.MISS 46X33 LEFT LOWER DOOR COLUMN CAP	1	PZ																																																																									
VT1061A2	EXTERNAL YELLOW SER.GLASS 598X424X5	1	PZ																																																																									
Code	Description	Qty	UOM																																																																									
IP1385A1	CORNER POLYSTYREN E PACKING 110X80X2000	0.810	M																																																																									

COMPONENT			SPARE PART																																																																						
Code	Description	Image	Code	Description	Components list																																																																				
VM1920A	INTERNAL GLASS CLOSING RIGHT PLATE		KVT1057A	LM STEFANIA BLACK EXTERNAL GLASS KIT	<table border="1"> <thead> <tr> <th>Code</th> <th>Description</th> <th>Qty</th> <th>UOM</th> </tr> </thead> <tbody> <tr> <td>IP1508A0</td> <td></td> <td>0.950</td> <td>PZ</td> </tr> <tr> <td>IP1508A1</td> <td>POLYSTYREN E U SHAPED PROFILE 2000X60X60</td> <td>0.960</td> <td>M</td> </tr> <tr> <td>RC1200A0</td> <td>ED=4 WIRE D.=0.5 COMPRESSIO N SPRING</td> <td>2</td> <td>PZ</td> </tr> <tr> <td>SL1050A1</td> <td>3M TRANSFER ADHESIVE TAPE</td> <td>0.660</td> <td>M</td> </tr> <tr> <td>TB2306A0</td> <td>LMISS STEFANIA/ELE NA DOOR RIGHT COLUM</td> <td>2</td> <td>PZ</td> </tr> <tr> <td>TB3080A0</td> <td>LMISS STEFANIA/ELE NA DOOR LEFT COLUMN</td> <td>1</td> <td>PZ</td> </tr> <tr> <td>VM1025A0</td> <td>Ø16 GREY NYLON LID</td> <td>2</td> <td>PZ</td> </tr> <tr> <td>VM1059A1</td> <td>HEAT SHRINK FILM H800</td> <td>1</td> <td>M</td> </tr> <tr> <td>VM1695A0</td> <td>HANDLE POSITION PIN</td> <td>2</td> <td>PZ</td> </tr> <tr> <td>VM1920A0</td> <td>INTERNAL GLASS CLOSING RIGHT PLATE</td> <td>1</td> <td>PZ</td> </tr> <tr> <td>VM1921A0</td> <td>INTERNAL GLASS CLOSING LEFT PLATE</td> <td>1</td> <td>PZ</td> </tr> <tr> <td>VM2062A0</td> <td>L.MISS 46X33 RIGHT UPPER DOOR COLUMN CAP</td> <td>1</td> <td>PZ</td> </tr> <tr> <td>VM2063A0</td> <td>L.MISS 46X33 LEFT UPPER DOOR COLUMN CAP</td> <td>1</td> <td>PZ</td> </tr> <tr> <td>VM2064A0</td> <td>L.MISS 46X33 RIGHT LOWER DOOR COLUMN CAP</td> <td>1</td> <td>PZ</td> </tr> <tr> <td>VM2065A0</td> <td>L.MISS 46X33 LEFT LOWER DOOR COLUMN CAP</td> <td>1</td> <td>PZ</td> </tr> <tr> <td>VT1057A0</td> <td>L.MISS STEFANIA EXTERNAL GLASS 598X344X5</td> <td>1</td> <td>PZ</td> </tr> </tbody> </table>	Code	Description	Qty	UOM	IP1508A0		0.950	PZ	IP1508A1	POLYSTYREN E U SHAPED PROFILE 2000X60X60	0.960	M	RC1200A0	ED=4 WIRE D.=0.5 COMPRESSIO N SPRING	2	PZ	SL1050A1	3M TRANSFER ADHESIVE TAPE	0.660	M	TB2306A0	LMISS STEFANIA/ELE NA DOOR RIGHT COLUM	2	PZ	TB3080A0	LMISS STEFANIA/ELE NA DOOR LEFT COLUMN	1	PZ	VM1025A0	Ø16 GREY NYLON LID	2	PZ	VM1059A1	HEAT SHRINK FILM H800	1	M	VM1695A0	HANDLE POSITION PIN	2	PZ	VM1920A0	INTERNAL GLASS CLOSING RIGHT PLATE	1	PZ	VM1921A0	INTERNAL GLASS CLOSING LEFT PLATE	1	PZ	VM2062A0	L.MISS 46X33 RIGHT UPPER DOOR COLUMN CAP	1	PZ	VM2063A0	L.MISS 46X33 LEFT UPPER DOOR COLUMN CAP	1	PZ	VM2064A0	L.MISS 46X33 RIGHT LOWER DOOR COLUMN CAP	1	PZ	VM2065A0	L.MISS 46X33 LEFT LOWER DOOR COLUMN CAP	1	PZ	VT1057A0	L.MISS STEFANIA EXTERNAL GLASS 598X344X5	1	PZ
Code	Description	Qty	UOM																																																																						
IP1508A0		0.950	PZ																																																																						
IP1508A1	POLYSTYREN E U SHAPED PROFILE 2000X60X60	0.960	M																																																																						
RC1200A0	ED=4 WIRE D.=0.5 COMPRESSIO N SPRING	2	PZ																																																																						
SL1050A1	3M TRANSFER ADHESIVE TAPE	0.660	M																																																																						
TB2306A0	LMISS STEFANIA/ELE NA DOOR RIGHT COLUM	2	PZ																																																																						
TB3080A0	LMISS STEFANIA/ELE NA DOOR LEFT COLUMN	1	PZ																																																																						
VM1025A0	Ø16 GREY NYLON LID	2	PZ																																																																						
VM1059A1	HEAT SHRINK FILM H800	1	M																																																																						
VM1695A0	HANDLE POSITION PIN	2	PZ																																																																						
VM1920A0	INTERNAL GLASS CLOSING RIGHT PLATE	1	PZ																																																																						
VM1921A0	INTERNAL GLASS CLOSING LEFT PLATE	1	PZ																																																																						
VM2062A0	L.MISS 46X33 RIGHT UPPER DOOR COLUMN CAP	1	PZ																																																																						
VM2063A0	L.MISS 46X33 LEFT UPPER DOOR COLUMN CAP	1	PZ																																																																						
VM2064A0	L.MISS 46X33 RIGHT LOWER DOOR COLUMN CAP	1	PZ																																																																						
VM2065A0	L.MISS 46X33 LEFT LOWER DOOR COLUMN CAP	1	PZ																																																																						
VT1057A0	L.MISS STEFANIA EXTERNAL GLASS 598X344X5	1	PZ																																																																						

COMPONENT			SPARE PART																																																																						
Code	Description	Image	Code	Description	Components list																																																																				
VM1920A	INTERNAL GLASS CLOSING RIGHT PLATE		KVT1056A	LM STEFANIA YELLOW EXTERNAL GLASS KIT	<table border="1"> <thead> <tr> <th>Code</th> <th>Description</th> <th>Qty</th> <th>UOM</th> </tr> </thead> <tbody> <tr> <td>IP1385A1</td> <td>CORNER POLYSTYREN E PACKING 110X80X2000</td> <td>0.980</td> <td>M</td> </tr> <tr> <td>IP1508A0</td> <td></td> <td>0.960</td> <td>PZ</td> </tr> <tr> <td>IP1508A1</td> <td>POLYSTYREN E U SHAPED PROFILE 2000X60X60</td> <td>0.960</td> <td>M</td> </tr> <tr> <td>RC1200A0</td> <td>ED=4 WIRE D.=0.5 COMPRESSIO N SPRING</td> <td>2</td> <td>PZ</td> </tr> <tr> <td>SL1050A1</td> <td>3M TRANSFER ADHESIVE TAPE</td> <td>0.660</td> <td>M</td> </tr> <tr> <td>TB2306A0</td> <td>LMISS STEFANIA/ELE NA DOOR RIGHT COLUM</td> <td>2</td> <td>PZ</td> </tr> <tr> <td>VM1025A0</td> <td>Ø16 GREY NYLON LID</td> <td>2</td> <td>PZ</td> </tr> <tr> <td>VM1059A1</td> <td>HEAT SHRINK FILM H800</td> <td>1.300</td> <td>M</td> </tr> <tr> <td>VM1695A0</td> <td>HANDLE POSITION PIN</td> <td>2</td> <td>PZ</td> </tr> <tr> <td>VM1920A0</td> <td>INTERNAL GLASS CLOSING RIGHT PLATE</td> <td>1</td> <td>PZ</td> </tr> <tr> <td>VM1921A0</td> <td>INTERNAL GLASS CLOSING LEFT PLATE</td> <td>1</td> <td>PZ</td> </tr> <tr> <td>VM2062A0</td> <td>L.MISS 46X33 RIGHT UPPER DOOR COLUMN CAP</td> <td>1</td> <td>PZ</td> </tr> <tr> <td>VM2063A0</td> <td>L.MISS 46X33 LEFT UPPER DOOR COLUMN CAP</td> <td>1</td> <td>PZ</td> </tr> <tr> <td>VM2064A0</td> <td>L.MISS 46X33 RIGHT LOWER DOOR COLUMN CAP</td> <td>1</td> <td>PZ</td> </tr> <tr> <td>VM2065A0</td> <td>L.MISS 46X33 LEFT LOWER DOOR COLUMN CAP</td> <td>1</td> <td>PZ</td> </tr> <tr> <td>VT1056A2</td> <td>YELLOW SER GLASS 598X344X5</td> <td>1</td> <td>PZ</td> </tr> </tbody> </table>	Code	Description	Qty	UOM	IP1385A1	CORNER POLYSTYREN E PACKING 110X80X2000	0.980	M	IP1508A0		0.960	PZ	IP1508A1	POLYSTYREN E U SHAPED PROFILE 2000X60X60	0.960	M	RC1200A0	ED=4 WIRE D.=0.5 COMPRESSIO N SPRING	2	PZ	SL1050A1	3M TRANSFER ADHESIVE TAPE	0.660	M	TB2306A0	LMISS STEFANIA/ELE NA DOOR RIGHT COLUM	2	PZ	VM1025A0	Ø16 GREY NYLON LID	2	PZ	VM1059A1	HEAT SHRINK FILM H800	1.300	M	VM1695A0	HANDLE POSITION PIN	2	PZ	VM1920A0	INTERNAL GLASS CLOSING RIGHT PLATE	1	PZ	VM1921A0	INTERNAL GLASS CLOSING LEFT PLATE	1	PZ	VM2062A0	L.MISS 46X33 RIGHT UPPER DOOR COLUMN CAP	1	PZ	VM2063A0	L.MISS 46X33 LEFT UPPER DOOR COLUMN CAP	1	PZ	VM2064A0	L.MISS 46X33 RIGHT LOWER DOOR COLUMN CAP	1	PZ	VM2065A0	L.MISS 46X33 LEFT LOWER DOOR COLUMN CAP	1	PZ	VT1056A2	YELLOW SER GLASS 598X344X5	1	PZ
Code	Description	Qty	UOM																																																																						
IP1385A1	CORNER POLYSTYREN E PACKING 110X80X2000	0.980	M																																																																						
IP1508A0		0.960	PZ																																																																						
IP1508A1	POLYSTYREN E U SHAPED PROFILE 2000X60X60	0.960	M																																																																						
RC1200A0	ED=4 WIRE D.=0.5 COMPRESSIO N SPRING	2	PZ																																																																						
SL1050A1	3M TRANSFER ADHESIVE TAPE	0.660	M																																																																						
TB2306A0	LMISS STEFANIA/ELE NA DOOR RIGHT COLUM	2	PZ																																																																						
VM1025A0	Ø16 GREY NYLON LID	2	PZ																																																																						
VM1059A1	HEAT SHRINK FILM H800	1.300	M																																																																						
VM1695A0	HANDLE POSITION PIN	2	PZ																																																																						
VM1920A0	INTERNAL GLASS CLOSING RIGHT PLATE	1	PZ																																																																						
VM1921A0	INTERNAL GLASS CLOSING LEFT PLATE	1	PZ																																																																						
VM2062A0	L.MISS 46X33 RIGHT UPPER DOOR COLUMN CAP	1	PZ																																																																						
VM2063A0	L.MISS 46X33 LEFT UPPER DOOR COLUMN CAP	1	PZ																																																																						
VM2064A0	L.MISS 46X33 RIGHT LOWER DOOR COLUMN CAP	1	PZ																																																																						
VM2065A0	L.MISS 46X33 LEFT LOWER DOOR COLUMN CAP	1	PZ																																																																						
VT1056A2	YELLOW SER GLASS 598X344X5	1	PZ																																																																						

COMPONENT			SPARE PART																																																																									
Code	Description	Image	Code	Description	Components list																																																																							
VM1920A	INTERNAL GLASS CLOSING RIGHT PLATE		KVT1052A	LM CRISTINA BLACK EXTERNAL GLASS KIT	<table border="1"> <thead> <tr> <th>Code</th> <th>Description</th> <th>Qty</th> <th>UOM</th> </tr> </thead> <tbody> <tr> <td>RC1200A0</td> <td>ED=4 WIRE D.=0.5 COMPRESSIO N SPRING</td> <td>2</td> <td>PZ</td> </tr> <tr> <td>SL1050A1</td> <td>3M TRANSFER ADHESIVE TAPE</td> <td>0.660</td> <td>M</td> </tr> <tr> <td>TB2306A0</td> <td>LMISS STEFANIA/ELE NA DOOR RIGHT COLUM</td> <td>2</td> <td>PZ</td> </tr> <tr> <td>VM1025A0</td> <td>Ø16 GREY NYLON LID</td> <td>2</td> <td>PZ</td> </tr> <tr> <td>VM1695A0</td> <td>HANDLE POSITION PIN</td> <td>2</td> <td>PZ</td> </tr> <tr> <td>VM1920A0</td> <td>INTERNAL GLASS CLOSING RIGHT PLATE</td> <td>1</td> <td>PZ</td> </tr> <tr> <td>VM1921A0</td> <td>INTERNAL GLASS CLOSING LEFT PLATE</td> <td>1</td> <td>PZ</td> </tr> <tr> <td>VM2062A0</td> <td>L.MISS 46X33 RIGHT UPPER DOOR COLUMN CAP</td> <td>1</td> <td>PZ</td> </tr> <tr> <td>VM2063A0</td> <td>L.MISS 46X33 LEFT UPPER DOOR COLUMN CAP</td> <td>1</td> <td>PZ</td> </tr> <tr> <td>VM2064A0</td> <td>L.MISS 46X33 RIGHT LOWER DOOR COLUMN CAP</td> <td>1</td> <td>PZ</td> </tr> <tr> <td>VM2065A0</td> <td>L.MISS 46X33 LEFT LOWER DOOR COLUMN CAP</td> <td>1</td> <td>PZ</td> </tr> <tr> <td>VT1052A0</td> <td>478X344X5 EXTERNAL GLASS</td> <td>1</td> <td>PZ</td> </tr> </tbody> </table>	Code	Description	Qty	UOM	RC1200A0	ED=4 WIRE D.=0.5 COMPRESSIO N SPRING	2	PZ	SL1050A1	3M TRANSFER ADHESIVE TAPE	0.660	M	TB2306A0	LMISS STEFANIA/ELE NA DOOR RIGHT COLUM	2	PZ	VM1025A0	Ø16 GREY NYLON LID	2	PZ	VM1695A0	HANDLE POSITION PIN	2	PZ	VM1920A0	INTERNAL GLASS CLOSING RIGHT PLATE	1	PZ	VM1921A0	INTERNAL GLASS CLOSING LEFT PLATE	1	PZ	VM2062A0	L.MISS 46X33 RIGHT UPPER DOOR COLUMN CAP	1	PZ	VM2063A0	L.MISS 46X33 LEFT UPPER DOOR COLUMN CAP	1	PZ	VM2064A0	L.MISS 46X33 RIGHT LOWER DOOR COLUMN CAP	1	PZ	VM2065A0	L.MISS 46X33 LEFT LOWER DOOR COLUMN CAP	1	PZ	VT1052A0	478X344X5 EXTERNAL GLASS	1	PZ	KVT1051A	LM CRISTINA YELLOW EXTERNAL GLASS KIT	<table border="1"> <thead> <tr> <th>Code</th> <th>Description</th> <th>Qty</th> <th>UOM</th> </tr> </thead> <tbody> <tr> <td>IP1385A1</td> <td>CORNER POLYSTYREN E PACKING 110X80X2000</td> <td>1.040</td> <td>M</td> </tr> <tr> <td>RC1200A0</td> <td>ED=4 WIRE D.=0.5 COMPRESSIO N SPRING</td> <td>2</td> <td>PZ</td> </tr> <tr> <td>SL1050A1</td> <td>3M TRANSFER ADHESIVE TAPE</td> <td>0.660</td> <td>M</td> </tr> </tbody> </table>	Code	Description	Qty	UOM	IP1385A1	CORNER POLYSTYREN E PACKING 110X80X2000	1.040	M	RC1200A0	ED=4 WIRE D.=0.5 COMPRESSIO N SPRING	2	PZ	SL1050A1	3M TRANSFER ADHESIVE TAPE	0.660	M
			Code	Description	Qty	UOM																																																																						
RC1200A0	ED=4 WIRE D.=0.5 COMPRESSIO N SPRING	2	PZ																																																																									
SL1050A1	3M TRANSFER ADHESIVE TAPE	0.660	M																																																																									
TB2306A0	LMISS STEFANIA/ELE NA DOOR RIGHT COLUM	2	PZ																																																																									
VM1025A0	Ø16 GREY NYLON LID	2	PZ																																																																									
VM1695A0	HANDLE POSITION PIN	2	PZ																																																																									
VM1920A0	INTERNAL GLASS CLOSING RIGHT PLATE	1	PZ																																																																									
VM1921A0	INTERNAL GLASS CLOSING LEFT PLATE	1	PZ																																																																									
VM2062A0	L.MISS 46X33 RIGHT UPPER DOOR COLUMN CAP	1	PZ																																																																									
VM2063A0	L.MISS 46X33 LEFT UPPER DOOR COLUMN CAP	1	PZ																																																																									
VM2064A0	L.MISS 46X33 RIGHT LOWER DOOR COLUMN CAP	1	PZ																																																																									
VM2065A0	L.MISS 46X33 LEFT LOWER DOOR COLUMN CAP	1	PZ																																																																									
VT1052A0	478X344X5 EXTERNAL GLASS	1	PZ																																																																									
Code	Description	Qty	UOM																																																																									
IP1385A1	CORNER POLYSTYREN E PACKING 110X80X2000	1.040	M																																																																									
RC1200A0	ED=4 WIRE D.=0.5 COMPRESSIO N SPRING	2	PZ																																																																									
SL1050A1	3M TRANSFER ADHESIVE TAPE	0.660	M																																																																									

COMPONENT			SPARE PART																																																		
Code	Description	Image	Code	Description	Components list																																																
VM1920A	INTERNAL GLASS CLOSING RIGHT PLATE		KVT1051A	LM CRISTINA YELLOW EXTERNAL GLASS KIT	<table border="1"> <thead> <tr> <th>Code</th> <th>Description</th> <th>Qty</th> <th>UOM</th> </tr> </thead> <tbody> <tr> <td>TB2306A0</td> <td>LMISS STEFANIA/ELE NA DOOR RIGHT COLUM</td> <td>2</td> <td>PZ</td> </tr> <tr> <td>VM1025A0</td> <td>Ø16 GREY NYLON LID</td> <td>2</td> <td>PZ</td> </tr> <tr> <td>VM1059A1</td> <td>HEAT SHRINK FILM H800</td> <td>1.500</td> <td>M</td> </tr> <tr> <td>VM1695A0</td> <td>HANDLE POSITION PIN</td> <td>2</td> <td>PZ</td> </tr> <tr> <td>VM1920A0</td> <td>INTERNAL GLASS CLOSING RIGHT PLATE</td> <td>1</td> <td>PZ</td> </tr> <tr> <td>VM1921A0</td> <td>INTERNAL GLASS CLOSING LEFT PLATE</td> <td>1</td> <td>PZ</td> </tr> <tr> <td>VM2062A0</td> <td>L.MISS 46X33 RIGHT UPPER DOOR COLUMN CAP</td> <td>1</td> <td>PZ</td> </tr> <tr> <td>VM2063A0</td> <td>L.MISS 46X33 LEFT UPPER DOOR COLUMN CAP</td> <td>1</td> <td>PZ</td> </tr> <tr> <td>VM2064A0</td> <td>L.MISS 46X33 RIGHT LOWER DOOR COLUMN CAP</td> <td>1</td> <td>PZ</td> </tr> <tr> <td>VM2065A0</td> <td>L.MISS 46X33 LEFT LOWER DOOR COLUMN CAP</td> <td>1</td> <td>PZ</td> </tr> <tr> <td>VT1051A2</td> <td>YELLOW SER GLASS 478X344X5</td> <td>1</td> <td>PZ</td> </tr> </tbody> </table>	Code	Description	Qty	UOM	TB2306A0	LMISS STEFANIA/ELE NA DOOR RIGHT COLUM	2	PZ	VM1025A0	Ø16 GREY NYLON LID	2	PZ	VM1059A1	HEAT SHRINK FILM H800	1.500	M	VM1695A0	HANDLE POSITION PIN	2	PZ	VM1920A0	INTERNAL GLASS CLOSING RIGHT PLATE	1	PZ	VM1921A0	INTERNAL GLASS CLOSING LEFT PLATE	1	PZ	VM2062A0	L.MISS 46X33 RIGHT UPPER DOOR COLUMN CAP	1	PZ	VM2063A0	L.MISS 46X33 LEFT UPPER DOOR COLUMN CAP	1	PZ	VM2064A0	L.MISS 46X33 RIGHT LOWER DOOR COLUMN CAP	1	PZ	VM2065A0	L.MISS 46X33 LEFT LOWER DOOR COLUMN CAP	1	PZ	VT1051A2	YELLOW SER GLASS 478X344X5	1	PZ
Code	Description	Qty	UOM																																																		
TB2306A0	LMISS STEFANIA/ELE NA DOOR RIGHT COLUM	2	PZ																																																		
VM1025A0	Ø16 GREY NYLON LID	2	PZ																																																		
VM1059A1	HEAT SHRINK FILM H800	1.500	M																																																		
VM1695A0	HANDLE POSITION PIN	2	PZ																																																		
VM1920A0	INTERNAL GLASS CLOSING RIGHT PLATE	1	PZ																																																		
VM1921A0	INTERNAL GLASS CLOSING LEFT PLATE	1	PZ																																																		
VM2062A0	L.MISS 46X33 RIGHT UPPER DOOR COLUMN CAP	1	PZ																																																		
VM2063A0	L.MISS 46X33 LEFT UPPER DOOR COLUMN CAP	1	PZ																																																		
VM2064A0	L.MISS 46X33 RIGHT LOWER DOOR COLUMN CAP	1	PZ																																																		
VM2065A0	L.MISS 46X33 LEFT LOWER DOOR COLUMN CAP	1	PZ																																																		
VT1051A2	YELLOW SER GLASS 478X344X5	1	PZ																																																		
VM1917A	LEFT UPPER COLUMN CAP		KVM1917A	LMISS 60X40 LEFT UPPER DOOR COLUMN CAP	<table border="1"> <thead> <tr> <th>Code</th> <th>Description</th> <th>Qty</th> <th>UOM</th> </tr> </thead> <tbody> <tr> <td>VM1917A0</td> <td>LEFT UPPER COLUMN CAP</td> <td>1</td> <td>PZ</td> </tr> </tbody> </table>	Code	Description	Qty	UOM	VM1917A0	LEFT UPPER COLUMN CAP	1	PZ																																								
Code	Description	Qty	UOM																																																		
VM1917A0	LEFT UPPER COLUMN CAP	1	PZ																																																		



COMPONENT			SPARE PART																										
Code	Description	Image	Code	Description	Components list																								
LP1036A	LINEMISS L=100 LED BAR		KLP1036A	LMISS L200 LED BAR KIT	<table border="1"> <thead> <tr> <th>Code</th> <th>Description</th> <th>Qty</th> <th>UOM</th> </tr> </thead> <tbody> <tr> <td>IP1385A1</td> <td>CORNER POLYSTYREN E PACKING 110X80X2000</td> <td>0.700</td> <td>M</td> </tr> <tr> <td>LP1030A0</td> <td></td> <td>1</td> <td>PZ</td> </tr> <tr> <td>LP1036A2</td> <td>L200 E200 LM LUX COMPLETE LED BAR</td> <td>1</td> <td>PZ</td> </tr> <tr> <td>VM1058A1</td> <td>HEAT SHRINK FILM H410</td> <td>0.700</td> <td>M</td> </tr> <tr> <td>VM1059A1</td> <td>HEAT SHRINK FILM H800</td> <td>0.700</td> <td>M</td> </tr> </tbody> </table>	Code	Description	Qty	UOM	IP1385A1	CORNER POLYSTYREN E PACKING 110X80X2000	0.700	M	LP1030A0		1	PZ	LP1036A2	L200 E200 LM LUX COMPLETE LED BAR	1	PZ	VM1058A1	HEAT SHRINK FILM H410	0.700	M	VM1059A1	HEAT SHRINK FILM H800	0.700	M
Code	Description	Qty	UOM																										
IP1385A1	CORNER POLYSTYREN E PACKING 110X80X2000	0.700	M																										
LP1030A0		1	PZ																										
LP1036A2	L200 E200 LM LUX COMPLETE LED BAR	1	PZ																										
VM1058A1	HEAT SHRINK FILM H410	0.700	M																										
VM1059A1	HEAT SHRINK FILM H800	0.700	M																										

ASM2012D/0.D00 - Cooking chamber



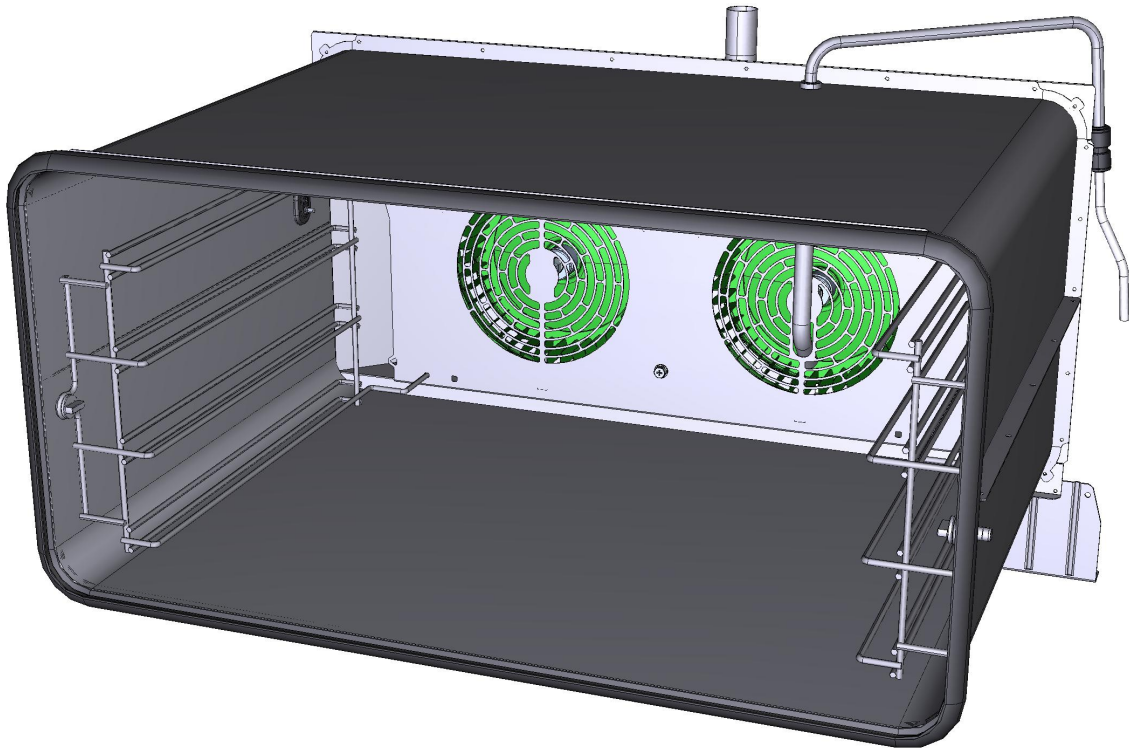

FRONT



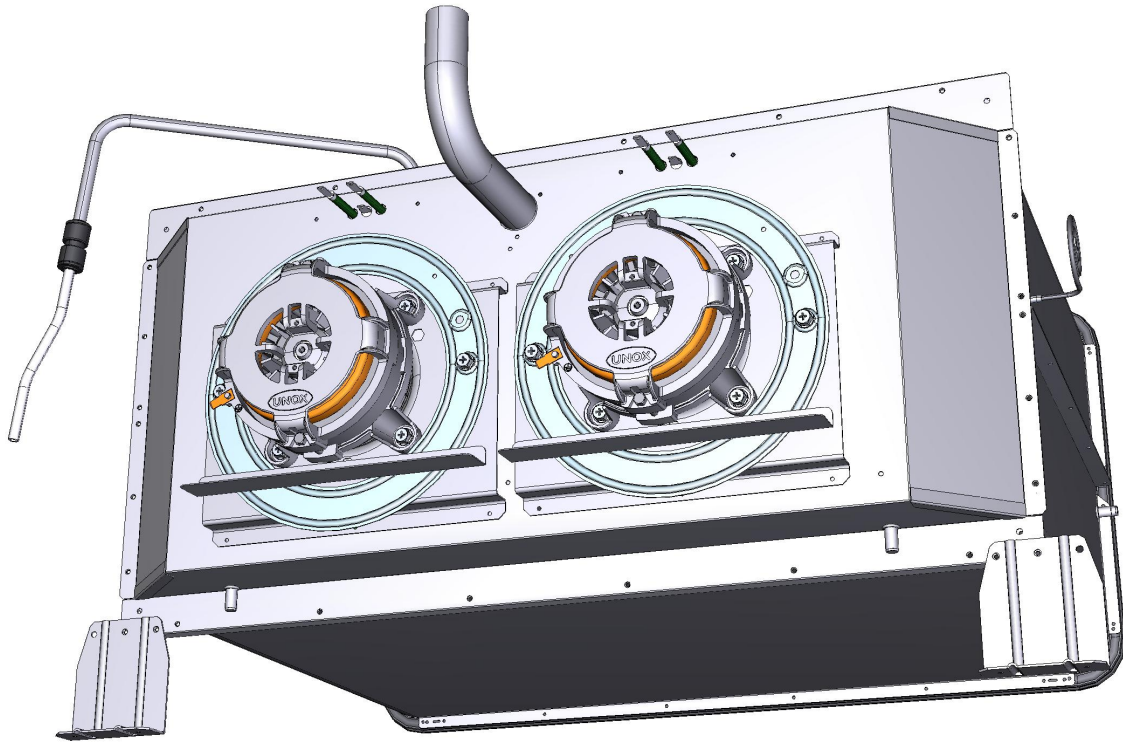



ASM2012D/0.D00 - Cooking chamber





REAR

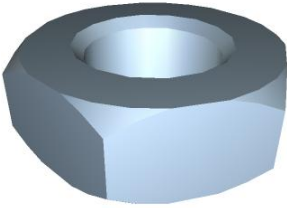



COMPONENT			SPARE PART																										
Code	Description	Image	Code	Description	Components list																								
0G1524B	XFT200 FAN GUARD SPACER		0G1524B0	XFT200 FAN GUARD SPACER																									
0G1537A	ROSSELLA STAINLESS STEEL FAN GUARD		0G1537A1	ROSSELLA STAINLESS STEEL FAN GUARD																									
0H3586A	ZINCED MOTOR GUARD PLATE XBC-XVC		0H3586A0	ZINCED MOTOR GUARD PLATE XBC-XVC																									
VN1025A	D=196 H=61 38 BLADES ST. STEEL FAN		KVN1025A	SERIES 5/5E XVC-XBC D196 H61 FAN KIT	<table border="1"> <thead> <tr> <th>Code</th> <th>Description</th> <th>Qty</th> <th>UOM</th> </tr> </thead> <tbody> <tr> <td>VI1045A0</td> <td>16X8,4 TH=1,6 ST.STEEL WASHER</td> <td>1</td> <td>PZ</td> </tr> <tr> <td>VI1255A0</td> <td>M8 H=8 BRASS-CHRO MED NUT</td> <td>2</td> <td>PZ</td> </tr> <tr> <td>VI1256A0</td> <td>M8 DIN 980M ST. STEEL SELF LOCKING NUT</td> <td>1</td> <td>PZ</td> </tr> <tr> <td>VM2196A0</td> <td>MOTOR NUT FIXING BUSHING</td> <td>1</td> <td>PZ</td> </tr> <tr> <td>VN1025A2</td> <td>D=196 H=61 38 BLADES ST. STEEL FAN</td> <td>1</td> <td>PZ</td> </tr> </tbody> </table>	Code	Description	Qty	UOM	VI1045A0	16X8,4 TH=1,6 ST.STEEL WASHER	1	PZ	VI1255A0	M8 H=8 BRASS-CHRO MED NUT	2	PZ	VI1256A0	M8 DIN 980M ST. STEEL SELF LOCKING NUT	1	PZ	VM2196A0	MOTOR NUT FIXING BUSHING	1	PZ	VN1025A2	D=196 H=61 38 BLADES ST. STEEL FAN	1	PZ
Code	Description	Qty	UOM																										
VI1045A0	16X8,4 TH=1,6 ST.STEEL WASHER	1	PZ																										
VI1255A0	M8 H=8 BRASS-CHRO MED NUT	2	PZ																										
VI1256A0	M8 DIN 980M ST. STEEL SELF LOCKING NUT	1	PZ																										
VM2196A0	MOTOR NUT FIXING BUSHING	1	PZ																										
VN1025A2	D=196 H=61 38 BLADES ST. STEEL FAN	1	PZ																										

COMPONENT			SPARE PART																																										
Code	Description	Image	Code	Description	Components list																																								
0H3020A	MOTOR SHAFT SEALING DISC		0H3020A1	MOTOR SHAFT SEALING DISC																																									
0H1209A	PROFILE HEAT COVER FOR MOTOR		0H1209A0	PROFILE HEAT COVER FOR MOTOR																																									
GN1547A	SHAFT GASKET D11.6																																												
VN1130A	330W 230V 50/60HZ MOTOR		KVN1130A	330W 230V 50/60HZ MOTOR KIT	<table border="1"> <thead> <tr> <th>Code</th> <th>Description</th> <th>Qty</th> <th>UOM</th> </tr> </thead> <tbody> <tr> <td>0H4305A1</td> <td>ST. STEEL MOTOR SHAFT SEALING DISC</td> <td>1</td> <td>PZ</td> </tr> <tr> <td>GN1140A2</td> <td>MOTOR HOLDER GASKET</td> <td>1</td> <td>PZ</td> </tr> <tr> <td>V11045A0</td> <td>16X8,4 TH=1,6 ST.STEEL WASHER</td> <td>1</td> <td>PZ</td> </tr> <tr> <td>V11255A0</td> <td>M8 H=8 BRASS-CHRO MED NUT</td> <td>2</td> <td>PZ</td> </tr> <tr> <td>V11256A0</td> <td>M8 DIN 980M ST. STEEL SELF LOCKING NUT</td> <td>1</td> <td>PZ</td> </tr> <tr> <td>VM1794A0</td> <td>250X4.8 PA66 BLACK CLAMP</td> <td>4</td> <td>PZ</td> </tr> <tr> <td>VM2103A0</td> <td>CLAMP LOCK</td> <td>4</td> <td>PZ</td> </tr> <tr> <td>VM2196A0</td> <td>MOTOR NUT FIXING BUSHING</td> <td>1</td> <td>PZ</td> </tr> <tr> <td>VN1130A1</td> <td>330W 230V 50/60HZ MOTO</td> <td>1</td> <td>PZ</td> </tr> </tbody> </table>	Code	Description	Qty	UOM	0H4305A1	ST. STEEL MOTOR SHAFT SEALING DISC	1	PZ	GN1140A2	MOTOR HOLDER GASKET	1	PZ	V11045A0	16X8,4 TH=1,6 ST.STEEL WASHER	1	PZ	V11255A0	M8 H=8 BRASS-CHRO MED NUT	2	PZ	V11256A0	M8 DIN 980M ST. STEEL SELF LOCKING NUT	1	PZ	VM1794A0	250X4.8 PA66 BLACK CLAMP	4	PZ	VM2103A0	CLAMP LOCK	4	PZ	VM2196A0	MOTOR NUT FIXING BUSHING	1	PZ	VN1130A1	330W 230V 50/60HZ MOTO	1	PZ
Code	Description	Qty	UOM																																										
0H4305A1	ST. STEEL MOTOR SHAFT SEALING DISC	1	PZ																																										
GN1140A2	MOTOR HOLDER GASKET	1	PZ																																										
V11045A0	16X8,4 TH=1,6 ST.STEEL WASHER	1	PZ																																										
V11255A0	M8 H=8 BRASS-CHRO MED NUT	2	PZ																																										
V11256A0	M8 DIN 980M ST. STEEL SELF LOCKING NUT	1	PZ																																										
VM1794A0	250X4.8 PA66 BLACK CLAMP	4	PZ																																										
VM2103A0	CLAMP LOCK	4	PZ																																										
VM2196A0	MOTOR NUT FIXING BUSHING	1	PZ																																										
VN1130A1	330W 230V 50/60HZ MOTO	1	PZ																																										

COMPONENT			SPARE PART																														
Code	Description	Image	Code	Description	Components list																												
RS1090A	2,9KW HEATING ELEMENT		KRS1090A	HEATING ELEMENT 2.9KW	<table border="1"> <thead> <tr> <th>Code</th> <th>Description</th> <th>Qty</th> <th>UOM</th> </tr> </thead> <tbody> <tr> <td>GN1327A0</td> <td>HEATING ELEMENT GASKET</td> <td>1</td> <td>PZ</td> </tr> <tr> <td>RS1090A1</td> <td>2.9KW HEATING ELEMENT</td> <td>1</td> <td>PZ</td> </tr> <tr> <td>SL1045A0</td> <td>S53 BLACK SILICONE - 80ML CARTRIDGE</td> <td>1</td> <td>PZ</td> </tr> <tr> <td>VI1220A1</td> <td>4,2X12 TCB SELF-TAPPING SCREW</td> <td>5</td> <td>PZ</td> </tr> <tr> <td>VM1794A0</td> <td>250X4.8 PA66 BLACK CLAMP</td> <td>2</td> <td>PZ</td> </tr> <tr> <td>VM2103A0</td> <td>CLAMP LOCK</td> <td>2</td> <td>PZ</td> </tr> </tbody> </table>	Code	Description	Qty	UOM	GN1327A0	HEATING ELEMENT GASKET	1	PZ	RS1090A1	2.9KW HEATING ELEMENT	1	PZ	SL1045A0	S53 BLACK SILICONE - 80ML CARTRIDGE	1	PZ	VI1220A1	4,2X12 TCB SELF-TAPPING SCREW	5	PZ	VM1794A0	250X4.8 PA66 BLACK CLAMP	2	PZ	VM2103A0	CLAMP LOCK	2	PZ
Code	Description	Qty	UOM																														
GN1327A0	HEATING ELEMENT GASKET	1	PZ																														
RS1090A1	2.9KW HEATING ELEMENT	1	PZ																														
SL1045A0	S53 BLACK SILICONE - 80ML CARTRIDGE	1	PZ																														
VI1220A1	4,2X12 TCB SELF-TAPPING SCREW	5	PZ																														
VM1794A0	250X4.8 PA66 BLACK CLAMP	2	PZ																														
VM2103A0	CLAMP LOCK	2	PZ																														
RC1170A	STAINLESS STEEL NUT M14 H=8 CH=22		KRC1170A	M14 H8 CH22 NUT - 10 PCS. KIT	<table border="1"> <thead> <tr> <th>Code</th> <th>Description</th> <th>Qty</th> <th>UOM</th> </tr> </thead> <tbody> <tr> <td>RC1170A1</td> <td>STAINLESS STEEL NUT M14 H=8 CH=22</td> <td>10</td> <td>PZ</td> </tr> </tbody> </table>	Code	Description	Qty	UOM	RC1170A1	STAINLESS STEEL NUT M14 H=8 CH=22	10	PZ																				
Code	Description	Qty	UOM																														
RC1170A1	STAINLESS STEEL NUT M14 H=8 CH=22	10	PZ																														
OH1990A	EXTERNAL WATER PIPE + RC1165A0		OH1990A1	EXTERNAL WATER PIPE + RC1165A0																													
EL1055A	Ø10 - Ø8 INT. REDUCTION		KEL1055A	Ø10-Ø8 JG REDUCTION 10 PCS KIT	<table border="1"> <thead> <tr> <th>Code</th> <th>Description</th> <th>Qty</th> <th>UOM</th> </tr> </thead> <tbody> <tr> <td>EL1055A0</td> <td>Ø10 - Ø8 INT. REDUCTION</td> <td>10</td> <td>PZ</td> </tr> </tbody> </table>	Code	Description	Qty	UOM	EL1055A0	Ø10 - Ø8 INT. REDUCTION	10	PZ																				
Code	Description	Qty	UOM																														
EL1055A0	Ø10 - Ø8 INT. REDUCTION	10	PZ																														

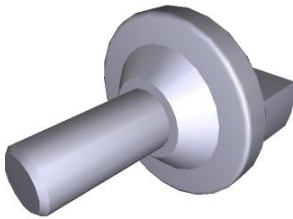
COMPONENT			SPARE PART														
Code	Description	Image	Code	Description	Components list												
TB2034A	L.MISS WATER SYSTEM - TB1815A		KTB2597A	Ø8 TRANSPARENT WATER PIPE 150 M KIT	<table border="1"> <thead> <tr> <th>Code</th> <th>Description</th> <th>Qty</th> <th>UOM</th> </tr> </thead> <tbody> <tr> <td>TB1815A0</td> <td>7,93X4,75 PE TRANSP. PIPE (JG #PE08100N)</td> <td>150</td> <td>M</td> </tr> <tr> <td>VM1059A1</td> <td>HEAT SHRINK FILM H800</td> <td>1.500</td> <td>M</td> </tr> </tbody> </table>	Code	Description	Qty	UOM	TB1815A0	7,93X4,75 PE TRANSP. PIPE (JG #PE08100N)	150	M	VM1059A1	HEAT SHRINK FILM H800	1.500	M
			Code	Description	Qty	UOM											
			TB1815A0	7,93X4,75 PE TRANSP. PIPE (JG #PE08100N)	150	M											
VM1059A1	HEAT SHRINK FILM H800	1.500	M														
KTB2529A	Ø8 TRANSPARENT HUMIDITY PIPE 2 M KIT	<table border="1"> <thead> <tr> <th>Code</th> <th>Description</th> <th>Qty</th> <th>UOM</th> </tr> </thead> <tbody> <tr> <td>TB1815A0</td> <td>7,93X4,75 PE TRANSP. PIPE (JG #PE08100N)</td> <td>3</td> <td>M</td> </tr> </tbody> </table>	Code	Description	Qty	UOM	TB1815A0	7,93X4,75 PE TRANSP. PIPE (JG #PE08100N)	3	M							
Code	Description	Qty	UOM														
TB1815A0	7,93X4,75 PE TRANSP. PIPE (JG #PE08100N)	3	M														
KTB1959A	7,93X4,75 PE TRANSPARENT PIPE 5M KIT	<table border="1"> <thead> <tr> <th>Code</th> <th>Description</th> <th>Qty</th> <th>UOM</th> </tr> </thead> <tbody> <tr> <td>TB1815A0</td> <td>7,93X4,75 PE TRANSP. PIPE (JG #PE08100N)</td> <td>5</td> <td>M</td> </tr> </tbody> </table>	Code	Description	Qty	UOM	TB1815A0	7,93X4,75 PE TRANSP. PIPE (JG #PE08100N)	5	M							
Code	Description	Qty	UOM														
TB1815A0	7,93X4,75 PE TRANSP. PIPE (JG #PE08100N)	5	M														
TB1098A	XFT200 INTERNAL HUMIDITY PIPE		TB1098A0	XFT200 INTERNAL HUMIDITY PIPE													
TB2121A	LINE MISS 800 EXHAUST CHIMNEY Ø30X1		TB2121A0	LINE MISS 800 EXHAUST CHIMNEY Ø30X1													
0H1455A	MUFFLE SUPPORT BRACKET		0H1455A2	MUFFLE SUPPORT BRACKET													

COMPONENT			SPARE PART																																		
Code	Description	Image	Code	Description	Components list																																
GRL1025A	RIGHT/LEFT LAT.GRID CHROMIUM-PLATED		KGRL1025A	LM ROSSELLA 4X60X40 LAT. SUPPORT KIT	<table border="1"> <thead> <tr> <th>Code</th> <th>Description</th> <th>Qty</th> <th>UOM</th> </tr> </thead> <tbody> <tr> <td>GRL1025A1</td> <td>RIGHT/LEFT LAT.GRID CHROMIUM-P LATED</td> <td>2</td> <td>PZ</td> </tr> <tr> <td>IP1508A0</td> <td></td> <td>2</td> <td>PZ</td> </tr> <tr> <td>IP1508A1</td> <td>POLYSTYREN E U SHAPED PROFILE 2000X60X60</td> <td>2</td> <td>M</td> </tr> <tr> <td>VM1059A1</td> <td>HEAT SHRINK FILM H800</td> <td>1.500</td> <td>M</td> </tr> </tbody> </table>	Code	Description	Qty	UOM	GRL1025A1	RIGHT/LEFT LAT.GRID CHROMIUM-P LATED	2	PZ	IP1508A0		2	PZ	IP1508A1	POLYSTYREN E U SHAPED PROFILE 2000X60X60	2	M	VM1059A1	HEAT SHRINK FILM H800	1.500	M												
Code	Description	Qty	UOM																																		
GRL1025A1	RIGHT/LEFT LAT.GRID CHROMIUM-P LATED	2	PZ																																		
IP1508A0		2	PZ																																		
IP1508A1	POLYSTYREN E U SHAPED PROFILE 2000X60X60	2	M																																		
VM1059A1	HEAT SHRINK FILM H800	1.500	M																																		
VM1815A	LATERAL SUPPORTS FIXING BOLT		KVM1815A	MISS/MICRO/S4/S3 THUMB SCREW 10 PCS KIT	<table border="1"> <thead> <tr> <th>Code</th> <th>Description</th> <th>Qty</th> <th>UOM</th> </tr> </thead> <tbody> <tr> <td>VM1815A0</td> <td>LATERAL SUPPORTS FIXING BOLT</td> <td>10</td> <td>PZ</td> </tr> </tbody> </table>	Code	Description	Qty	UOM	VM1815A0	LATERAL SUPPORTS FIXING BOLT	10	PZ																								
Code	Description	Qty	UOM																																		
VM1815A0	LATERAL SUPPORTS FIXING BOLT	10	PZ																																		
TR1105A	L=1000 PT1000 TEMPERATURE PROBE		KTR1105A	PT100 L1000 TEMPERATURE PROBE KIT	<table border="1"> <thead> <tr> <th>Code</th> <th>Description</th> <th>Qty</th> <th>UOM</th> </tr> </thead> <tbody> <tr> <td>GN1120A0</td> <td>TEMPERATUR E PROBE NTC SEAL</td> <td>1</td> <td>PZ</td> </tr> <tr> <td>GN1285A0</td> <td>NTC TEMPERATUR E PROBE SEALING</td> <td>1</td> <td>PZ</td> </tr> <tr> <td>SL1045A0</td> <td>S53 BLACK SILICONE - 80ML CARTRIDGE</td> <td>1</td> <td>PZ</td> </tr> <tr> <td>TR1105A3</td> <td>L=1000 PT1000 TEMPERATUR E PROBE</td> <td>1</td> <td>PZ</td> </tr> <tr> <td>TR1105A4</td> <td></td> <td>1</td> <td>PZ</td> </tr> <tr> <td>VH1220A1</td> <td>4,2X12 TCB SELF-TAPPIN G SCREW</td> <td>2</td> <td>PZ</td> </tr> <tr> <td>VM1465A0</td> <td>CHEFTOP TEMPERATUR E PROBE COVER</td> <td>1</td> <td>PZ</td> </tr> </tbody> </table>	Code	Description	Qty	UOM	GN1120A0	TEMPERATUR E PROBE NTC SEAL	1	PZ	GN1285A0	NTC TEMPERATUR E PROBE SEALING	1	PZ	SL1045A0	S53 BLACK SILICONE - 80ML CARTRIDGE	1	PZ	TR1105A3	L=1000 PT1000 TEMPERATUR E PROBE	1	PZ	TR1105A4		1	PZ	VH1220A1	4,2X12 TCB SELF-TAPPIN G SCREW	2	PZ	VM1465A0	CHEFTOP TEMPERATUR E PROBE COVER	1	PZ
Code	Description	Qty	UOM																																		
GN1120A0	TEMPERATUR E PROBE NTC SEAL	1	PZ																																		
GN1285A0	NTC TEMPERATUR E PROBE SEALING	1	PZ																																		
SL1045A0	S53 BLACK SILICONE - 80ML CARTRIDGE	1	PZ																																		
TR1105A3	L=1000 PT1000 TEMPERATUR E PROBE	1	PZ																																		
TR1105A4		1	PZ																																		
VH1220A1	4,2X12 TCB SELF-TAPPIN G SCREW	2	PZ																																		
VM1465A0	CHEFTOP TEMPERATUR E PROBE COVER	1	PZ																																		



COMPONENT			SPARE PART																		
Code	Description	Image	Code	Description	Components list																
GN1354A	LINEMISS ROSSELLA DOOR GASKET - GN1110A		KG1354A	LM ROSSELLA DOOR GASKET KIT	<table border="1"> <thead> <tr> <th>Code</th> <th>Description</th> <th>Qty</th> <th>UOM</th> </tr> </thead> <tbody> <tr> <td>GN1110A2</td> <td>LINE</td> <td>1.890</td> <td>M</td> </tr> <tr> <td></td> <td>MISS/XVC105-055/XK/XL</td> <td></td> <td></td> </tr> <tr> <td></td> <td>DOOR GASKE</td> <td></td> <td></td> </tr> </tbody> </table>	Code	Description	Qty	UOM	GN1110A2	LINE	1.890	M		MISS/XVC105-055/XK/XL				DOOR GASKE		
Code	Description	Qty	UOM																		
GN1110A2	LINE	1.890	M																		
	MISS/XVC105-055/XK/XL																				
	DOOR GASKE																				



ASM2013D/0.D01 - External cover

FRONT

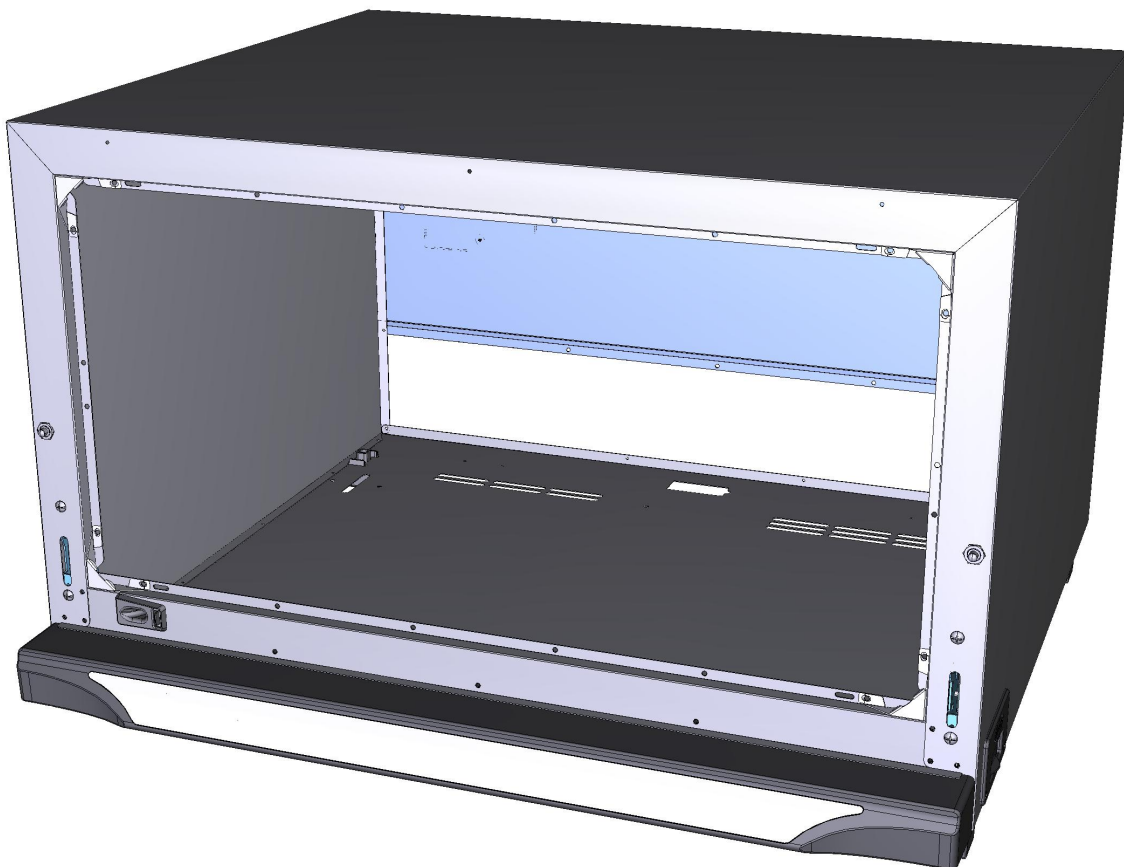





ASM2013D/0.D01 - External cover

REAR











COMPONENT			SPARE PART																		
Code	Description	Image	Code	Description	Components list																
VM1951A	IP CHIMNEY COVER		KVM1065A	LINE MISS EXHAUST CHIMNEY COVER	<table border="1"> <thead> <tr> <th>Code</th> <th>Description</th> <th>Qty</th> <th>UOM</th> </tr> </thead> <tbody> <tr> <td>VM1065A0</td> <td>L.M. EXHAUST CHIMNEY COVER</td> <td>1</td> <td>PZ</td> </tr> </tbody> </table>	Code	Description	Qty	UOM	VM1065A0	L.M. EXHAUST CHIMNEY COVER	1	PZ								
Code	Description	Qty	UOM																		
VM1065A0	L.M. EXHAUST CHIMNEY COVER	1	PZ																		
0H1450A	XB-XV-XG ST. STEEL MUFFLE FRONT CORNER		0H1450A0	XB-XV-XG ST. STEEL MUFFLE FRONT CORNER																	
PD1001A	35X35 H26 GREY PLASTIC+RUBBER FOOT		KPD1001A	35X35 H26 FEET 4PCS KIT	<table border="1"> <thead> <tr> <th>Code</th> <th>Description</th> <th>Qty</th> <th>UOM</th> </tr> </thead> <tbody> <tr> <td>PD1001A0</td> <td>35X35 H26 GREY PLASTIC+RUBBER FOOT</td> <td>4</td> <td>PZ</td> </tr> </tbody> </table>	Code	Description	Qty	UOM	PD1001A0	35X35 H26 GREY PLASTIC+RUBBER FOOT	4	PZ								
Code	Description	Qty	UOM																		
PD1001A0	35X35 H26 GREY PLASTIC+RUBBER FOOT	4	PZ																		
PE2012A	LINE MISS RJ45 UNOXLINK CONNECTING POIN		KPE2012A	LINEMISS RJ45 UNOX.LINK KIT	<table border="1"> <thead> <tr> <th>Code</th> <th>Description</th> <th>Qty</th> <th>UOM</th> </tr> </thead> <tbody> <tr> <td>PE2012A0</td> <td>LINE MISS RJ45 UNOXLINK CONNECTING POINT</td> <td>1</td> <td>PZ</td> </tr> <tr> <td>VI1960A0</td> <td>SELF-TAPPIN G SCREW 4.2X11 TCBS+ AISI410</td> <td>4</td> <td>PZ</td> </tr> </tbody> </table>	Code	Description	Qty	UOM	PE2012A0	LINE MISS RJ45 UNOXLINK CONNECTING POINT	1	PZ	VI1960A0	SELF-TAPPIN G SCREW 4.2X11 TCBS+ AISI410	4	PZ				
Code	Description	Qty	UOM																		
PE2012A0	LINE MISS RJ45 UNOXLINK CONNECTING POINT	1	PZ																		
VI1960A0	SELF-TAPPIN G SCREW 4.2X11 TCBS+ AISI410	4	PZ																		
CE1012A	L= 1MT RJ45 CABLE		KVM2190A	LM600 HAUBIS COMPLETE CONTROL BOARD KIT	<table border="1"> <thead> <tr> <th>Code</th> <th>Description</th> <th>Qty</th> <th>UOM</th> </tr> </thead> <tbody> <tr> <td>CE1012A0</td> <td>L= 1MT RJ45 CABLE</td> <td>1</td> <td>PZ</td> </tr> <tr> <td>MS1014A0</td> <td>L.MISS TOUCH MATIC CONTROL BOARD STICKER</td> <td>1</td> <td>PZ</td> </tr> <tr> <td>MS1014A1</td> <td>L.M. TOUCH DYNAMIC CONTROL BOARD STICKER</td> <td>1</td> <td>PZ</td> </tr> </tbody> </table>	Code	Description	Qty	UOM	CE1012A0	L= 1MT RJ45 CABLE	1	PZ	MS1014A0	L.MISS TOUCH MATIC CONTROL BOARD STICKER	1	PZ	MS1014A1	L.M. TOUCH DYNAMIC CONTROL BOARD STICKER	1	PZ
Code	Description	Qty	UOM																		
CE1012A0	L= 1MT RJ45 CABLE	1	PZ																		
MS1014A0	L.MISS TOUCH MATIC CONTROL BOARD STICKER	1	PZ																		
MS1014A1	L.M. TOUCH DYNAMIC CONTROL BOARD STICKER	1	PZ																		



COMPONENT			SPARE PART																															
Code	Description	Image	Code	Description	Components list																													
CE1012A	L= 1MT RJ45 CABLE		KVM2190A	LM600 HAUBIS COMPLETE CONTROL BOARD KIT	<table border="1"> <thead> <tr> <th>Code</th> <th>Description</th> <th>Qty</th> <th>UOM</th> </tr> </thead> <tbody> <tr> <td>PE2018B0</td> <td>LMISS TOUCH CONTROL BOARD</td> <td>1</td> <td>PZ</td> </tr> <tr> <td>VI1635A0</td> <td>M4X8 ZINC PLATED FLAT HEAD SCREW</td> <td>5</td> <td>PZ</td> </tr> <tr> <td>VM1794A0</td> <td>250X4.8 PA66 BLACK CLAMP</td> <td>2</td> <td>PZ</td> </tr> <tr> <td>VM2016A0</td> <td>LMISS TOUCH 46X33 DYNAMIC CONTROL BOARD</td> <td>1</td> <td>PZ</td> </tr> <tr> <td>VM2103A0</td> <td>CLAMP LOCK</td> <td>2</td> <td>PZ</td> </tr> <tr> <td>VM2190A0</td> <td>LINEMISS HAUBIS 46X33 COMPLETE CONTROL</td> <td>1</td> <td>PZ</td> </tr> </tbody> </table>	Code	Description	Qty	UOM	PE2018B0	LMISS TOUCH CONTROL BOARD	1	PZ	VI1635A0	M4X8 ZINC PLATED FLAT HEAD SCREW	5	PZ	VM1794A0	250X4.8 PA66 BLACK CLAMP	2	PZ	VM2016A0	LMISS TOUCH 46X33 DYNAMIC CONTROL BOARD	1	PZ	VM2103A0	CLAMP LOCK	2	PZ	VM2190A0	LINEMISS HAUBIS 46X33 COMPLETE CONTROL	1	PZ	
			Code	Description	Qty	UOM																												
			PE2018B0	LMISS TOUCH CONTROL BOARD	1	PZ																												
VI1635A0	M4X8 ZINC PLATED FLAT HEAD SCREW	5	PZ																															
VM1794A0	250X4.8 PA66 BLACK CLAMP	2	PZ																															
VM2016A0	LMISS TOUCH 46X33 DYNAMIC CONTROL BOARD	1	PZ																															
VM2103A0	CLAMP LOCK	2	PZ																															
VM2190A0	LINEMISS HAUBIS 46X33 COMPLETE CONTROL	1	PZ																															
KVM2186A	LMISS 46X33 MATIC-TOP CONTROL BOARD KIT	<table border="1"> <thead> <tr> <th>Code</th> <th>Description</th> <th>Qty</th> <th>UOM</th> </tr> </thead> <tbody> <tr> <td>CE1012A0</td> <td>L= 1MT RJ45 CABLE</td> <td>1</td> <td>PZ</td> </tr> <tr> <td>MS1014A0</td> <td>LMISS TOUCH MATIC CONTROL BOARD STICKER</td> <td>1</td> <td>PZ</td> </tr> <tr> <td>PE1980B0</td> <td>LINE MISS TOUCH CONTROL BOARD</td> <td>1</td> <td>PZ</td> </tr> <tr> <td>VI1635A0</td> <td>M4X8 ZINC PLATED FLAT HEAD SCREW</td> <td>5</td> <td>PZ</td> </tr> <tr> <td>VM1794A0</td> <td>250X4.8 PA66 BLACK CLAMP</td> <td>2</td> <td>PZ</td> </tr> <tr> <td>VM2016A0</td> <td>LMISS TOUCH 46X33 DYNAMIC CONTROL BOARD</td> <td>1</td> <td>PZ</td> </tr> <tr> <td>VM2103A0</td> <td>CLAMP LOCK</td> <td>2</td> <td>PZ</td> </tr> </tbody> </table>	Code	Description	Qty	UOM	CE1012A0	L= 1MT RJ45 CABLE	1	PZ	MS1014A0	LMISS TOUCH MATIC CONTROL BOARD STICKER	1	PZ	PE1980B0	LINE MISS TOUCH CONTROL BOARD	1	PZ	VI1635A0	M4X8 ZINC PLATED FLAT HEAD SCREW	5	PZ	VM1794A0	250X4.8 PA66 BLACK CLAMP	2	PZ	VM2016A0	LMISS TOUCH 46X33 DYNAMIC CONTROL BOARD	1	PZ	VM2103A0	CLAMP LOCK	2	PZ
Code	Description	Qty	UOM																															
CE1012A0	L= 1MT RJ45 CABLE	1	PZ																															
MS1014A0	LMISS TOUCH MATIC CONTROL BOARD STICKER	1	PZ																															
PE1980B0	LINE MISS TOUCH CONTROL BOARD	1	PZ																															
VI1635A0	M4X8 ZINC PLATED FLAT HEAD SCREW	5	PZ																															
VM1794A0	250X4.8 PA66 BLACK CLAMP	2	PZ																															
VM2016A0	LMISS TOUCH 46X33 DYNAMIC CONTROL BOARD	1	PZ																															
VM2103A0	CLAMP LOCK	2	PZ																															
KVM2185A	LMISS 46X33 DYNAMIC CONTROL BOARD KIT	<table border="1"> <thead> <tr> <th>Code</th> <th>Description</th> <th>Qty</th> <th>UOM</th> </tr> </thead> <tbody> <tr> <td>CE1012A0</td> <td>L= 1MT RJ45 CABLE</td> <td>1</td> <td>PZ</td> </tr> <tr> <td>MS1012A0</td> <td>LMISS TOUCH DYN. CONTROL BOARD STICKER</td> <td>1</td> <td>PZ</td> </tr> <tr> <td>PE1980B0</td> <td>LINE MISS TOUCH CONTROL BOARD</td> <td>1</td> <td>PZ</td> </tr> </tbody> </table>	Code	Description	Qty	UOM	CE1012A0	L= 1MT RJ45 CABLE	1	PZ	MS1012A0	LMISS TOUCH DYN. CONTROL BOARD STICKER	1	PZ	PE1980B0	LINE MISS TOUCH CONTROL BOARD	1	PZ																
Code	Description	Qty	UOM																															
CE1012A0	L= 1MT RJ45 CABLE	1	PZ																															
MS1012A0	LMISS TOUCH DYN. CONTROL BOARD STICKER	1	PZ																															
PE1980B0	LINE MISS TOUCH CONTROL BOARD	1	PZ																															

COMPONENT			SPARE PART																															
Code	Description	Image	Code	Description	Components list																													
CE1012A	L= 1MT RJ45 CABLE		KVM2185A	LMISS 46X33 DYNAMIC CONTROL BOARD KIT	<table border="1"> <thead> <tr> <th>Code</th> <th>Description</th> <th>Qty</th> <th>UOM</th> </tr> </thead> <tbody> <tr> <td>VI1635A0</td> <td>M4X8 ZINC PLATED FLAT HEAD SCREW</td> <td>5</td> <td>PZ</td> </tr> <tr> <td>VM1794A0</td> <td>250X4.8 PA66 BLACK CLAMP</td> <td>2</td> <td>PZ</td> </tr> <tr> <td>VM2016A0</td> <td>LMISS TOUCH 46X33 DYNAMIC CONTROL BOARD</td> <td>1</td> <td>PZ</td> </tr> <tr> <td>VM2103A0</td> <td>CLAMP LOCK</td> <td>2</td> <td>PZ</td> </tr> </tbody> </table>	Code	Description	Qty	UOM	VI1635A0	M4X8 ZINC PLATED FLAT HEAD SCREW	5	PZ	VM1794A0	250X4.8 PA66 BLACK CLAMP	2	PZ	VM2016A0	LMISS TOUCH 46X33 DYNAMIC CONTROL BOARD	1	PZ	VM2103A0	CLAMP LOCK	2	PZ									
			Code	Description	Qty	UOM																												
			VI1635A0	M4X8 ZINC PLATED FLAT HEAD SCREW	5	PZ																												
VM1794A0	250X4.8 PA66 BLACK CLAMP	2	PZ																															
VM2016A0	LMISS TOUCH 46X33 DYNAMIC CONTROL BOARD	1	PZ																															
VM2103A0	CLAMP LOCK	2	PZ																															
KVM2184A	LINEMISS 46X33 CLASSIC CONTROL BOARD KIT	<table border="1"> <thead> <tr> <th>Code</th> <th>Description</th> <th>Qty</th> <th>UOM</th> </tr> </thead> <tbody> <tr> <td>CE1012A0</td> <td>L= 1MT RJ45 CABLE</td> <td>1</td> <td>PZ</td> </tr> <tr> <td>MS1016A0</td> <td>L.M. TOUCH CLASSIC CONTROL BOARD STICKER</td> <td>1</td> <td>PZ</td> </tr> <tr> <td>PE1980B0</td> <td>LINE MISS TOUCH CONTROL BOARD</td> <td>1</td> <td>PZ</td> </tr> <tr> <td>VI1635A0</td> <td>M4X8 ZINC PLATED FLAT HEAD SCREW</td> <td>5</td> <td>PZ</td> </tr> <tr> <td>VM1794A0</td> <td>250X4.8 PA66 BLACK CLAMP</td> <td>2</td> <td>PZ</td> </tr> <tr> <td>VM2016A0</td> <td>L.MISS TOUCH 46X33 DYNAMIC CONTROL BOARD</td> <td>1</td> <td>PZ</td> </tr> <tr> <td>VM2103A0</td> <td>CLAMP LOCK</td> <td>2</td> <td>PZ</td> </tr> </tbody> </table>	Code	Description	Qty	UOM	CE1012A0	L= 1MT RJ45 CABLE	1	PZ	MS1016A0	L.M. TOUCH CLASSIC CONTROL BOARD STICKER	1	PZ	PE1980B0	LINE MISS TOUCH CONTROL BOARD	1	PZ	VI1635A0	M4X8 ZINC PLATED FLAT HEAD SCREW	5	PZ	VM1794A0	250X4.8 PA66 BLACK CLAMP	2	PZ	VM2016A0	L.MISS TOUCH 46X33 DYNAMIC CONTROL BOARD	1	PZ	VM2103A0	CLAMP LOCK	2	PZ
Code	Description	Qty	UOM																															
CE1012A0	L= 1MT RJ45 CABLE	1	PZ																															
MS1016A0	L.M. TOUCH CLASSIC CONTROL BOARD STICKER	1	PZ																															
PE1980B0	LINE MISS TOUCH CONTROL BOARD	1	PZ																															
VI1635A0	M4X8 ZINC PLATED FLAT HEAD SCREW	5	PZ																															
VM1794A0	250X4.8 PA66 BLACK CLAMP	2	PZ																															
VM2016A0	L.MISS TOUCH 46X33 DYNAMIC CONTROL BOARD	1	PZ																															
VM2103A0	CLAMP LOCK	2	PZ																															
KCE1012A	RJ45 CONTROL-POWER CONNECTING CABLE KIT	<table border="1"> <thead> <tr> <th>Code</th> <th>Description</th> <th>Qty</th> <th>UOM</th> </tr> </thead> <tbody> <tr> <td>CE1012A0</td> <td>L= 1MT RJ45 CABLE</td> <td>1</td> <td>PZ</td> </tr> </tbody> </table>	Code	Description	Qty	UOM	CE1012A0	L= 1MT RJ45 CABLE	1	PZ																								
Code	Description	Qty	UOM																															
CE1012A0	L= 1MT RJ45 CABLE	1	PZ																															
0D1285G	LM ROSSELLA EXTERNAL CASING		0D1285G0	LM ROSSELLA EXTERNAL CASING																														



COMPONENT			SPARE PART														
Code	Description	Image	Code	Description	Components list												
0E1081D	LM 800 EXTERNAL BOTTOM PANEL		0E1081D0	LM 800 EXTERNAL BOTTOM PANEL													
0F1095D	LM ROSSELLA EXTERNAL BACK PANEL		0F1095D0	LM ROSSELLA EXTERNAL BACK PANEL													
CR1000A	HINGE LATCH L.M.		KCR1000A	LM HINGES LATCH KIT	<table border="1"> <thead> <tr> <th>Code</th> <th>Description</th> <th>Qty</th> <th>UOM</th> </tr> </thead> <tbody> <tr> <td>CR1000A0</td> <td>HINGE LATCH L.M.</td> <td>1</td> <td>PZ</td> </tr> <tr> <td>VI1875A0</td> <td>SCREW M5X10 TC1/2T INOX</td> <td>2</td> <td>PZ</td> </tr> </tbody> </table>	Code	Description	Qty	UOM	CR1000A0	HINGE LATCH L.M.	1	PZ	VI1875A0	SCREW M5X10 TC1/2T INOX	2	PZ
Code	Description	Qty	UOM														
CR1000A0	HINGE LATCH L.M.	1	PZ														
VI1875A0	SCREW M5X10 TC1/2T INOX	2	PZ														
VE1295A	MK 16A 230V DOOR MICROSWITCH		KVE1295A	16A 230V DOOR MICROSWITCH KIT	<table border="1"> <thead> <tr> <th>Code</th> <th>Description</th> <th>Qty</th> <th>UOM</th> </tr> </thead> <tbody> <tr> <td>VE1295A0</td> <td>MK 16A 230V DOOR MICROSWITC</td> <td>1</td> <td>PZ</td> </tr> </tbody> </table>	Code	Description	Qty	UOM	VE1295A0	MK 16A 230V DOOR MICROSWITC	1	PZ				
Code	Description	Qty	UOM														
VE1295A0	MK 16A 230V DOOR MICROSWITC	1	PZ														
VM1225A	PLATE WITH HOLES FOR ELECTRONIC		VM1225A1	PLATE WITH HOLES FOR ELECTRONIC													



COMPONENT			SPARE PART																						
Code	Description	Image	Code	Description	Components list																				
0D1300C	LM 800 FRONT LOWER PROFILE		0D1300C0	LM 800 FRONT LOWER PROFILE																					
VM1556A	XBC-XVC COOLING FAN GUARD		KVM1556A	XBC-XVC COOLING FAN GUARD KIT	<table border="1"> <thead> <tr> <th>Code</th> <th>Description</th> <th>Qty</th> <th>UOM</th> </tr> </thead> <tbody> <tr> <td>VM1556A0</td> <td>XBC-XVC COOLING FAN GUARD</td> <td>1</td> <td>PZ</td> </tr> </tbody> </table>	Code	Description	Qty	UOM	VM1556A0	XBC-XVC COOLING FAN GUARD	1	PZ												
Code	Description	Qty	UOM																						
VM1556A0	XBC-XVC COOLING FAN GUARD	1	PZ																						
VN1178A	115V 60HZ COOLING FAN KIT 120X120		KVN1178A	120X120 115V 60HZ FAN MOTOR KIT	<table border="1"> <thead> <tr> <th>Code</th> <th>Description</th> <th>Qty</th> <th>UOM</th> </tr> </thead> <tbody> <tr> <td>VN1178A0</td> <td>115V 60HZ COOLING FAN KIT 120X120</td> <td>1</td> <td>PZ</td> </tr> </tbody> </table>	Code	Description	Qty	UOM	VN1178A0	115V 60HZ COOLING FAN KIT 120X120	1	PZ												
Code	Description	Qty	UOM																						
VN1178A0	115V 60HZ COOLING FAN KIT 120X120	1	PZ																						
VN1175A	230V 50/60HZ 120X120 COOLING DOWN FAN		KVN1175A	120X120 230V 50/60HZ COOLING FAN KIT	<table border="1"> <thead> <tr> <th>Code</th> <th>Description</th> <th>Qty</th> <th>UOM</th> </tr> </thead> <tbody> <tr> <td>VN1175A0</td> <td>230V 50/60HZ 120X120 COOLING DOWN FAN</td> <td>1</td> <td>PZ</td> </tr> </tbody> </table>	Code	Description	Qty	UOM	VN1175A0	230V 50/60HZ 120X120 COOLING DOWN FAN	1	PZ												
Code	Description	Qty	UOM																						
VN1175A0	230V 50/60HZ 120X120 COOLING DOWN FAN	1	PZ																						
VM2188B	LMISSTOUCH60X40 DYNAMIC COMPLETE CONTROL		KVM2188B	LM800 DYNAMIC COMPLETE CONTROL BOARD KIT	<table border="1"> <thead> <tr> <th>Code</th> <th>Description</th> <th>Qty</th> <th>UOM</th> </tr> </thead> <tbody> <tr> <td>MS1013A1</td> <td>L.MISS TOUCH DYN. CONTROL BOARD STICKER</td> <td>1</td> <td>PZ</td> </tr> <tr> <td>PE1980B0</td> <td>LINE MISS TOUCH CONTROL BOARD</td> <td>1</td> <td>PZ</td> </tr> <tr> <td>VH1635A0</td> <td>M4X8 ZINC PLATED FLAT HEAD SCREW</td> <td>1</td> <td>PZ</td> </tr> <tr> <td>VM1794A0</td> <td>250X4.8 PA66 BLACK CLAMP</td> <td>2</td> <td>PZ</td> </tr> </tbody> </table>	Code	Description	Qty	UOM	MS1013A1	L.MISS TOUCH DYN. CONTROL BOARD STICKER	1	PZ	PE1980B0	LINE MISS TOUCH CONTROL BOARD	1	PZ	VH1635A0	M4X8 ZINC PLATED FLAT HEAD SCREW	1	PZ	VM1794A0	250X4.8 PA66 BLACK CLAMP	2	PZ
Code	Description	Qty	UOM																						
MS1013A1	L.MISS TOUCH DYN. CONTROL BOARD STICKER	1	PZ																						
PE1980B0	LINE MISS TOUCH CONTROL BOARD	1	PZ																						
VH1635A0	M4X8 ZINC PLATED FLAT HEAD SCREW	1	PZ																						
VM1794A0	250X4.8 PA66 BLACK CLAMP	2	PZ																						

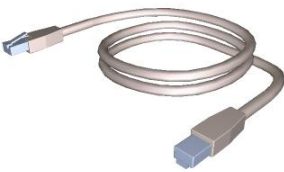

COMPONENT			SPARE PART																		
Code	Description	Image	Code	Description	Components list																
VM2188B	LMISSTOUCH60X40 DYNAMIC COMPLETE CONTROL		KVM2188B	LM800 DYNAMIC COMPLETE CONTROL BOARD KIT	<table border="1"> <thead> <tr> <th>Code</th> <th>Description</th> <th>Qty</th> <th>UOM</th> </tr> </thead> <tbody> <tr> <td>VM2017A0</td> <td>600X400 LINEMISS DYNAMIC CONTROL BOARD</td> <td>1</td> <td>PZ</td> </tr> <tr> <td>VM2103A0</td> <td>CLAMP LOCK</td> <td>2</td> <td>PZ</td> </tr> <tr> <td>VM2188B1</td> <td>LM800 DYNAMIC COMPLETE CONTROL BOARD</td> <td>1</td> <td>PZ</td> </tr> </tbody> </table>	Code	Description	Qty	UOM	VM2017A0	600X400 LINEMISS DYNAMIC CONTROL BOARD	1	PZ	VM2103A0	CLAMP LOCK	2	PZ	VM2188B1	LM800 DYNAMIC COMPLETE CONTROL BOARD	1	PZ
Code	Description	Qty	UOM																		
VM2017A0	600X400 LINEMISS DYNAMIC CONTROL BOARD	1	PZ																		
VM2103A0	CLAMP LOCK	2	PZ																		
VM2188B1	LM800 DYNAMIC COMPLETE CONTROL BOARD	1	PZ																		
CE1305A	L=2MT RJ45 - RJ45 CABLE		KCE1305A	RJ45 - RJ45 L=2MT CABLE KIT	<table border="1"> <thead> <tr> <th>Code</th> <th>Description</th> <th>Qty</th> <th>UOM</th> </tr> </thead> <tbody> <tr> <td>CE1305A0</td> <td>L=2MT RJ45 - RJ45 CABLE</td> <td>1</td> <td>PZ</td> </tr> </tbody> </table>	Code	Description	Qty	UOM	CE1305A0	L=2MT RJ45 - RJ45 CABLE	1	PZ								
Code	Description	Qty	UOM																		
CE1305A0	L=2MT RJ45 - RJ45 CABLE	1	PZ																		

ASM2014F/0.D00 - Electrical system

FRONT

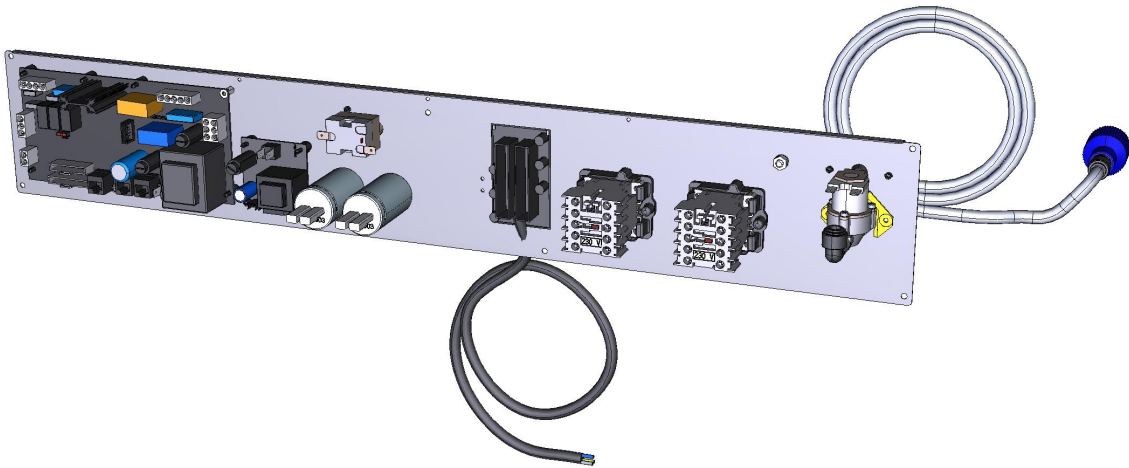

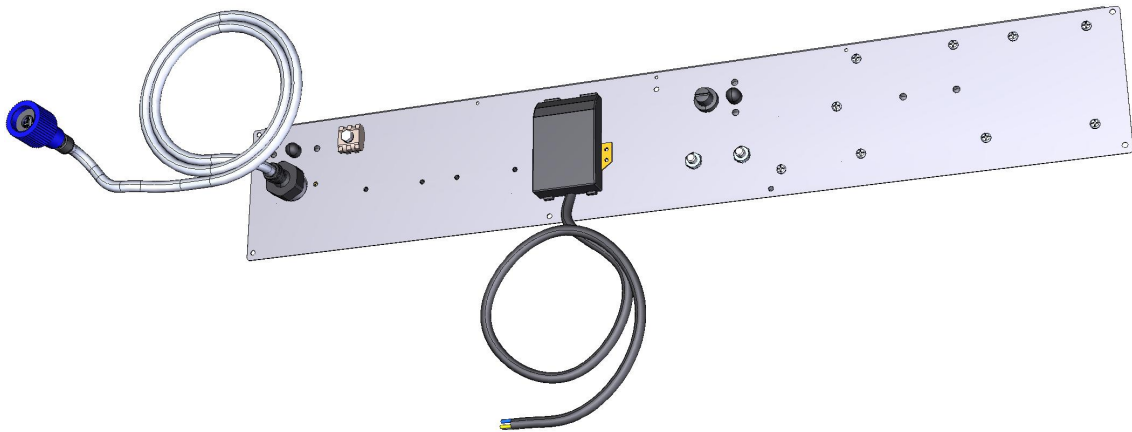

ASM2014F/0.D00 - Electrical system

REAR

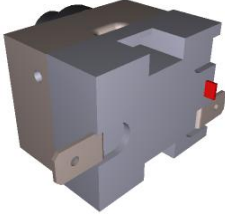
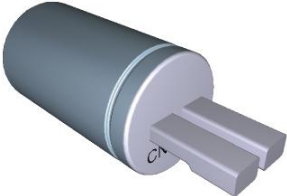
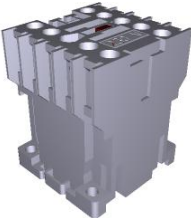

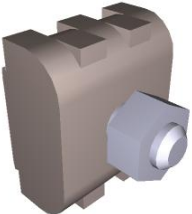
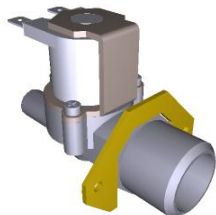

COMPONENT			SPARE PART																										
Code	Description	Image	Code	Description	Components list																								
CE1130A	5X1,5MMQ L=1,5M CABLE + TERMINAL BOARD		KCE1130A	5X1,5MMQ L=1,5M CABLE + TERMINAL BLOCK	<table border="1"> <thead> <tr> <th>Code</th> <th>Description</th> <th>Qty</th> <th>UOM</th> </tr> </thead> <tbody> <tr> <td>CE1130A1</td> <td>5X1,5MMQ L=1,5M CABLE + TERMINAL BOARD</td> <td>1</td> <td>PZ</td> </tr> </tbody> </table>	Code	Description	Qty	UOM	CE1130A1	5X1,5MMQ L=1,5M CABLE + TERMINAL BOARD	1	PZ																
Code	Description	Qty	UOM																										
CE1130A1	5X1,5MMQ L=1,5M CABLE + TERMINAL BOARD	1	PZ																										
TR1136A	330°C 1 POLE SAFETY THERMOSTAT		KTR1136A	330°C SAFETY THERMOSTAT KIT	<table border="1"> <thead> <tr> <th>Code</th> <th>Description</th> <th>Qty</th> <th>UOM</th> </tr> </thead> <tbody> <tr> <td>0H7030A0</td> <td>THERMOSTAT BULB INLET COVER</td> <td>1</td> <td>PZ</td> </tr> <tr> <td>GN1531A0</td> <td>THERMOSTAT BULB INLET SEALING</td> <td>1</td> <td>PZ</td> </tr> <tr> <td>SL1045A0</td> <td>S53 BLACK SILICONE - 80ML CARTRIDGE</td> <td>1</td> <td>PZ</td> </tr> <tr> <td>TR1136A0</td> <td>330°C 1 POLE SAFETY THERMOSTAT</td> <td>1</td> <td>PZ</td> </tr> <tr> <td>VI1220A1</td> <td>4,2X12 TCB SELF-TAPPIN G SCREW</td> <td>3</td> <td>PZ</td> </tr> </tbody> </table>	Code	Description	Qty	UOM	0H7030A0	THERMOSTAT BULB INLET COVER	1	PZ	GN1531A0	THERMOSTAT BULB INLET SEALING	1	PZ	SL1045A0	S53 BLACK SILICONE - 80ML CARTRIDGE	1	PZ	TR1136A0	330°C 1 POLE SAFETY THERMOSTAT	1	PZ	VI1220A1	4,2X12 TCB SELF-TAPPIN G SCREW	3	PZ
Code	Description	Qty	UOM																										
0H7030A0	THERMOSTAT BULB INLET COVER	1	PZ																										
GN1531A0	THERMOSTAT BULB INLET SEALING	1	PZ																										
SL1045A0	S53 BLACK SILICONE - 80ML CARTRIDGE	1	PZ																										
TR1136A0	330°C 1 POLE SAFETY THERMOSTAT	1	PZ																										
VI1220A1	4,2X12 TCB SELF-TAPPIN G SCREW	3	PZ																										
CN1003A	6,3 UF MOTOR CAPACITOR		KCN1003A	6,3 UF MOTOR CAPACITOR KIT	<table border="1"> <thead> <tr> <th>Code</th> <th>Description</th> <th>Qty</th> <th>UOM</th> </tr> </thead> <tbody> <tr> <td>CN1003A0</td> <td>6,3 UF MOTOR CAPACITOR</td> <td>1</td> <td>PZ</td> </tr> <tr> <td>VI1931A0</td> <td>M8 NUT+INDENTE D WASHER D=8 X COND.</td> <td>1</td> <td>PZ</td> </tr> <tr> <td>VI1932A0</td> <td>M8 NUT+INDENTE D WASHER D=8 X COND.</td> <td>1</td> <td>PZ</td> </tr> </tbody> </table>	Code	Description	Qty	UOM	CN1003A0	6,3 UF MOTOR CAPACITOR	1	PZ	VI1931A0	M8 NUT+INDENTE D WASHER D=8 X COND.	1	PZ	VI1932A0	M8 NUT+INDENTE D WASHER D=8 X COND.	1	PZ								
Code	Description	Qty	UOM																										
CN1003A0	6,3 UF MOTOR CAPACITOR	1	PZ																										
VI1931A0	M8 NUT+INDENTE D WASHER D=8 X COND.	1	PZ																										
VI1932A0	M8 NUT+INDENTE D WASHER D=8 X COND.	1	PZ																										
VE1115A	20 A 230V 4 POLES MINICONTACTOR		KVE1115A	20A 230V 4 POLES MINICONTACTOR KI	<table border="1"> <thead> <tr> <th>Code</th> <th>Description</th> <th>Qty</th> <th>UOM</th> </tr> </thead> <tbody> <tr> <td>VE1115A0</td> <td>20 A 230V 4 POLES MINICONTACT OR</td> <td>1</td> <td>PZ</td> </tr> <tr> <td>VM1075A1</td> <td>PLASTIC CLIP TO FIX CONTACTORS</td> <td>4</td> <td>PZ</td> </tr> </tbody> </table>	Code	Description	Qty	UOM	VE1115A0	20 A 230V 4 POLES MINICONTACT OR	1	PZ	VM1075A1	PLASTIC CLIP TO FIX CONTACTORS	4	PZ												
Code	Description	Qty	UOM																										
VE1115A0	20 A 230V 4 POLES MINICONTACT OR	1	PZ																										
VM1075A1	PLASTIC CLIP TO FIX CONTACTORS	4	PZ																										

COMPONENT			SPARE PART																										
Code	Description	Image	Code	Description	Components list																								
VM1056A	SMALL CONTACTOR BRACKET VE1115A		VM1056A0	SMALL CONTACTOR BRACKET VE1115A																									
VM1750A	BRASS COMB CLAM		KVM1750A	COMB TERMINAL BLOCK KIT	<table border="1"> <thead> <tr> <th>Code</th> <th>Description</th> <th>Qty</th> <th>UOM</th> </tr> </thead> <tbody> <tr> <td>VM1750A0</td> <td>BRASS COMB CLAMP</td> <td>1</td> <td>PZ</td> </tr> </tbody> </table>	Code	Description	Qty	UOM	VM1750A0	BRASS COMB CLAMP	1	PZ																
Code	Description	Qty	UOM																										
VM1750A0	BRASS COMB CLAMP	1	PZ																										
EL1085A	SINGLE WATER SOLENOID VALVE + J.GUEST		KEL1085A	1 WAY SOLENOID VALVE KIT	<table border="1"> <thead> <tr> <th>Code</th> <th>Description</th> <th>Qty</th> <th>UOM</th> </tr> </thead> <tbody> <tr> <td>EL1085A0</td> <td>SINGLE WATER SOLENOID VALVE + J.GUEST</td> <td>1</td> <td>PZ</td> </tr> </tbody> </table>	Code	Description	Qty	UOM	EL1085A0	SINGLE WATER SOLENOID VALVE + J.GUEST	1	PZ																
Code	Description	Qty	UOM																										
EL1085A0	SINGLE WATER SOLENOID VALVE + J.GUEST	1	PZ																										
TB1079A	L.MISS D8 WATER PIPE		KTB1079A	LINEMISS WATER INLET CONNECTING PIPE KIT	<table border="1"> <thead> <tr> <th>Code</th> <th>Description</th> <th>Qty</th> <th>UOM</th> </tr> </thead> <tbody> <tr> <td>GN1200A1</td> <td>3/4 CONNECTION SEAL D=24 RUBBER+NET</td> <td>1</td> <td>PZ</td> </tr> <tr> <td>RC1002A0</td> <td>JG 10M-8F TERMINAL REDUCTION FITTING</td> <td>1</td> <td>PZ</td> </tr> <tr> <td>RC1030A2</td> <td>Ø8-3/4 FEMALE JG STRAIGHT CONNECTION</td> <td>1</td> <td>PZ</td> </tr> <tr> <td>RC1365A0</td> <td>3/4"-10 JG FEMALE CONNECTION</td> <td>1</td> <td>PZ</td> </tr> <tr> <td>TB1815A0</td> <td>7,93X4,75 PE TRANSP. PIPE (JG #PE08100N)</td> <td>1.500</td> <td>M</td> </tr> </tbody> </table>	Code	Description	Qty	UOM	GN1200A1	3/4 CONNECTION SEAL D=24 RUBBER+NET	1	PZ	RC1002A0	JG 10M-8F TERMINAL REDUCTION FITTING	1	PZ	RC1030A2	Ø8-3/4 FEMALE JG STRAIGHT CONNECTION	1	PZ	RC1365A0	3/4"-10 JG FEMALE CONNECTION	1	PZ	TB1815A0	7,93X4,75 PE TRANSP. PIPE (JG #PE08100N)	1.500	M
Code	Description	Qty	UOM																										
GN1200A1	3/4 CONNECTION SEAL D=24 RUBBER+NET	1	PZ																										
RC1002A0	JG 10M-8F TERMINAL REDUCTION FITTING	1	PZ																										
RC1030A2	Ø8-3/4 FEMALE JG STRAIGHT CONNECTION	1	PZ																										
RC1365A0	3/4"-10 JG FEMALE CONNECTION	1	PZ																										
TB1815A0	7,93X4,75 PE TRANSP. PIPE (JG #PE08100N)	1.500	M																										

COMPONENT			SPARE PART																										
Code	Description	Image	Code	Description	Components list																								
RC1030A	Ø8-3/4 FEMALE JG STRAIGHT CONNECTION		KRC1030A	LMISS Ø8-3/4 STRAIGHT FITTING 5PCS KIT	<table border="1"> <thead> <tr> <th>Code</th> <th>Description</th> <th>Qty</th> <th>UOM</th> </tr> </thead> <tbody> <tr> <td>RC1030A2</td> <td>Ø8-3/4 FEMALE JG STRAIGHT CONNECTION</td> <td>5</td> <td>PZ</td> </tr> </tbody> </table>	Code	Description	Qty	UOM	RC1030A2	Ø8-3/4 FEMALE JG STRAIGHT CONNECTION	5	PZ																
Code	Description	Qty	UOM																										
RC1030A2	Ø8-3/4 FEMALE JG STRAIGHT CONNECTION	5	PZ																										
RC1002A	JG 10M-8F TERMINAL REDUCTION FITTING		KRC1002A	G Ø10M-Ø8F REDUCING SPIGOT 10 PCS KIT	<table border="1"> <thead> <tr> <th>Code</th> <th>Description</th> <th>Qty</th> <th>UOM</th> </tr> </thead> <tbody> <tr> <td>RC1002A0</td> <td>JG 10M-8F TERMINAL REDUCTION FITTING</td> <td>10</td> <td>PZ</td> </tr> </tbody> </table>	Code	Description	Qty	UOM	RC1002A0	JG 10M-8F TERMINAL REDUCTION FITTING	10	PZ																
Code	Description	Qty	UOM																										
RC1002A0	JG 10M-8F TERMINAL REDUCTION FITTING	10	PZ																										
RC1365A	3/4"-10 JG FEMALE CONNECTION		KRC1365A	3/4"-10 OR 8 JG WATER CONNECTION KIT	<table border="1"> <thead> <tr> <th>Code</th> <th>Description</th> <th>Qty</th> <th>UOM</th> </tr> </thead> <tbody> <tr> <td>GN1200A1</td> <td>3/4 CONNECTION SEAL D=24 RUBBER+NET</td> <td>1</td> <td>PZ</td> </tr> <tr> <td>RC1002A0</td> <td>JG 10M-8F TERMINAL REDUCTION FITTING</td> <td>1</td> <td>PZ</td> </tr> <tr> <td>RC1365A0</td> <td>3/4"-10 JG FEMALE CONNECTION</td> <td>1</td> <td>PZ</td> </tr> </tbody> </table>	Code	Description	Qty	UOM	GN1200A1	3/4 CONNECTION SEAL D=24 RUBBER+NET	1	PZ	RC1002A0	JG 10M-8F TERMINAL REDUCTION FITTING	1	PZ	RC1365A0	3/4"-10 JG FEMALE CONNECTION	1	PZ								
Code	Description	Qty	UOM																										
GN1200A1	3/4 CONNECTION SEAL D=24 RUBBER+NET	1	PZ																										
RC1002A0	JG 10M-8F TERMINAL REDUCTION FITTING	1	PZ																										
RC1365A0	3/4"-10 JG FEMALE CONNECTION	1	PZ																										
PE1983B	LMISS 230V DYNAMIC/CLASSIC POWER CARD		KPE1983B	LM 230V POWER BOARD KIT	<table border="1"> <thead> <tr> <th>Code</th> <th>Description</th> <th>Qty</th> <th>UOM</th> </tr> </thead> <tbody> <tr> <td>PE1983B0</td> <td>LMISS 230V DYNAMIC/CLASSIC POWER CARD</td> <td>1</td> <td>PZ</td> </tr> <tr> <td>PE1983B1</td> <td>LMISS 230V DYNAMIC POWER BOARD</td> <td>1</td> <td>PZ</td> </tr> <tr> <td>VI1850A0</td> <td>M4X6 NICKEL PLATED FIXING SCRE</td> <td>7</td> <td>PZ</td> </tr> <tr> <td>VM1745A0</td> <td>CARD SUPPORT</td> <td>6</td> <td>PZ</td> </tr> <tr> <td>VM2147A0</td> <td>ESD SPONGE PINK SMOOTH 410X343X15 M</td> <td>1</td> <td>PZ</td> </tr> </tbody> </table>	Code	Description	Qty	UOM	PE1983B0	LMISS 230V DYNAMIC/CLASSIC POWER CARD	1	PZ	PE1983B1	LMISS 230V DYNAMIC POWER BOARD	1	PZ	VI1850A0	M4X6 NICKEL PLATED FIXING SCRE	7	PZ	VM1745A0	CARD SUPPORT	6	PZ	VM2147A0	ESD SPONGE PINK SMOOTH 410X343X15 M	1	PZ
Code	Description	Qty	UOM																										
PE1983B0	LMISS 230V DYNAMIC/CLASSIC POWER CARD	1	PZ																										
PE1983B1	LMISS 230V DYNAMIC POWER BOARD	1	PZ																										
VI1850A0	M4X6 NICKEL PLATED FIXING SCRE	7	PZ																										
VM1745A0	CARD SUPPORT	6	PZ																										
VM2147A0	ESD SPONGE PINK SMOOTH 410X343X15 M	1	PZ																										



COMPONENT			SPARE PART																		
Code	Description	Image	Code	Description	Components list																
0H6221F	LM800 DYNAMIC MANUAL COMPONENTS HOLDER		0H6221F0	LM800 DYNAMIC MANUAL COMPONENTS HOLDER																	
PE1781A	200-240VAC 12VCC 1,5VA POWER SUPPLY		KPE1781A	240VAC 12VCC 1.5VA POWER SUPPLY KIT	<table border="1"> <thead> <tr> <th>Code</th> <th>Description</th> <th>Qty</th> <th>UOM</th> </tr> </thead> <tbody> <tr> <td>PE1781A0</td> <td>200-240VAC 12VCC 1,5VA POWER SUPPLY</td> <td>1</td> <td>PZ</td> </tr> <tr> <td>VM1745A0</td> <td>CARD SUPPORT</td> <td>4</td> <td>PZ</td> </tr> <tr> <td>VM2147A0</td> <td>ESD SPONGE PINK SMOOTH 410X343X15 M</td> <td>1</td> <td>PZ</td> </tr> </tbody> </table>	Code	Description	Qty	UOM	PE1781A0	200-240VAC 12VCC 1,5VA POWER SUPPLY	1	PZ	VM1745A0	CARD SUPPORT	4	PZ	VM2147A0	ESD SPONGE PINK SMOOTH 410X343X15 M	1	PZ
Code	Description	Qty	UOM																		
PE1781A0	200-240VAC 12VCC 1,5VA POWER SUPPLY	1	PZ																		
VM1745A0	CARD SUPPORT	4	PZ																		
VM2147A0	ESD SPONGE PINK SMOOTH 410X343X15 M	1	PZ																		